

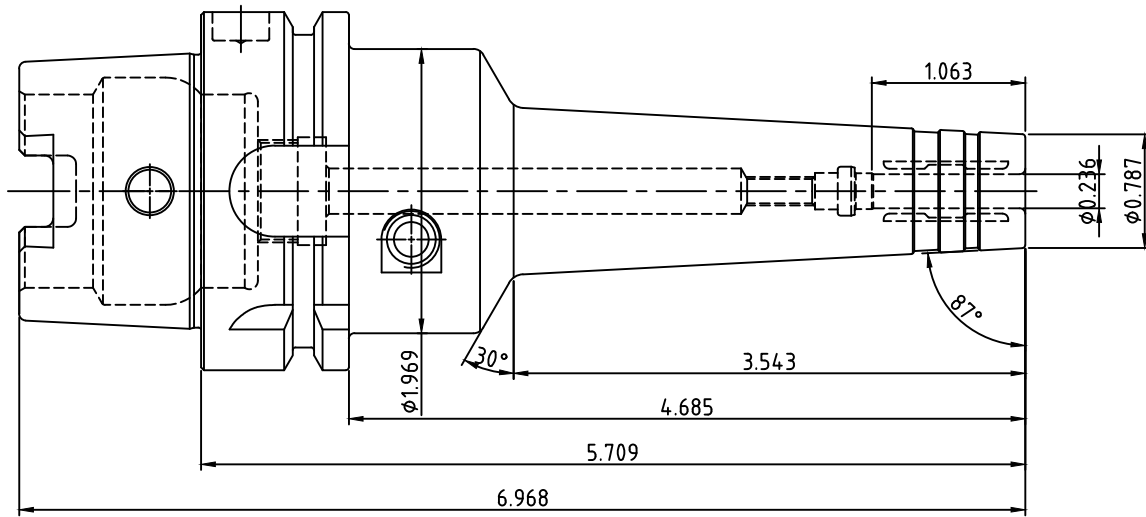

NO.	REVISIONS	DATE	DEVISER
1.			
2.			
3.			



 YG-1 CO., LTD.	DESCRIPTION		
	HSK63A-HMC0.24(6)-5.71(145)		
	EDP No.	WQ100HMC	SCALE 1 : 1