

NO.	REVISIONS	DATE	DEVISER
1.			
2.			
3.			

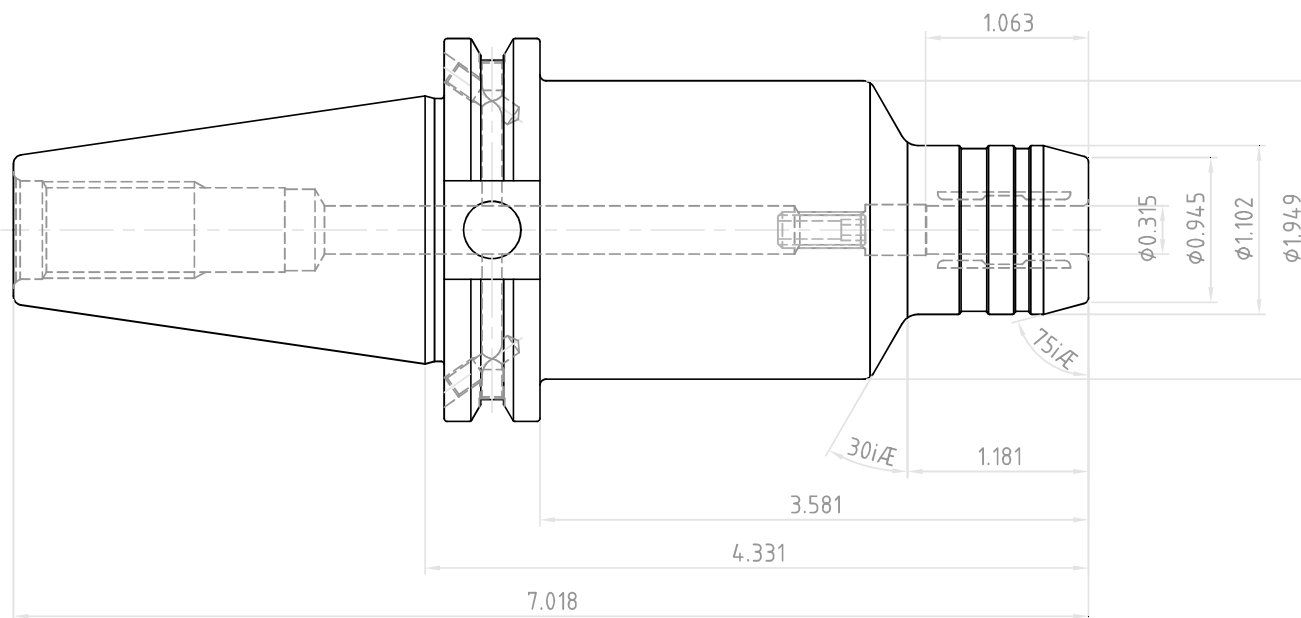

 YG-1 CO., LTD.	DESCRIPTION		
	CAT40AD/B-HC0.31(8)-4.33(110)		
	EDP No.	WK066	SCALE 1 : 1