

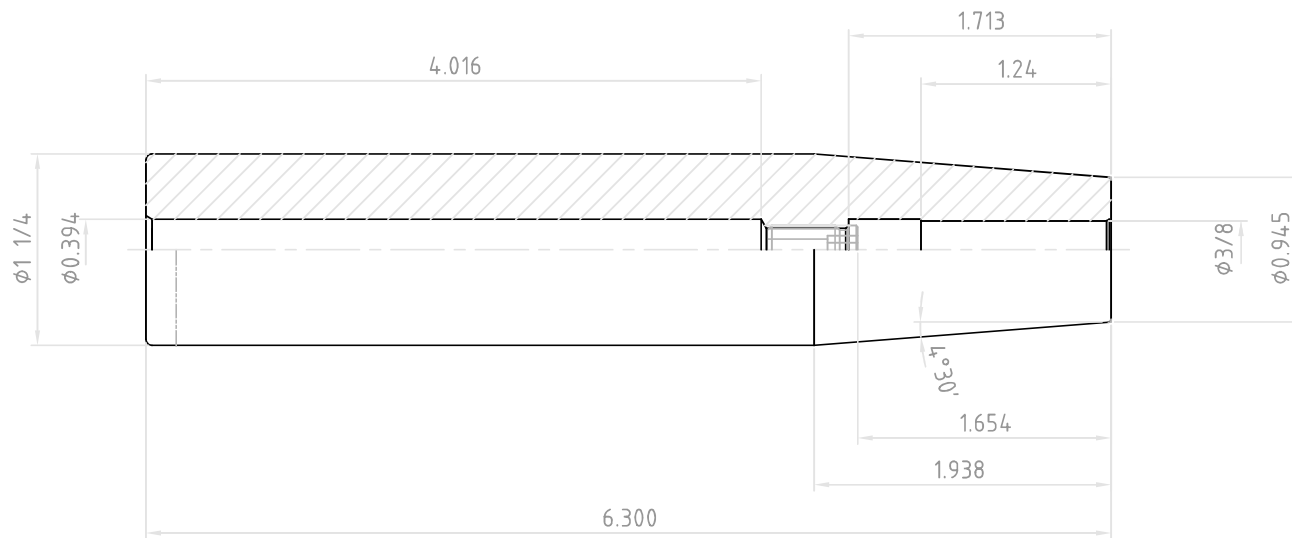

NO.	REVISIONS	DATE	DEVISER
1.			
2.			
3.			



 YG-1 CO., LTD.	SSK CONTROL NUMBER		
	ST1 1/4(31.75)-SFH3/8(9.525)-6.30(160)		
EDP No.	VS054	SCALE	1 : 1