

NO.	REVISIONS	DATE	DEVISER
1.			
2.			
3.			

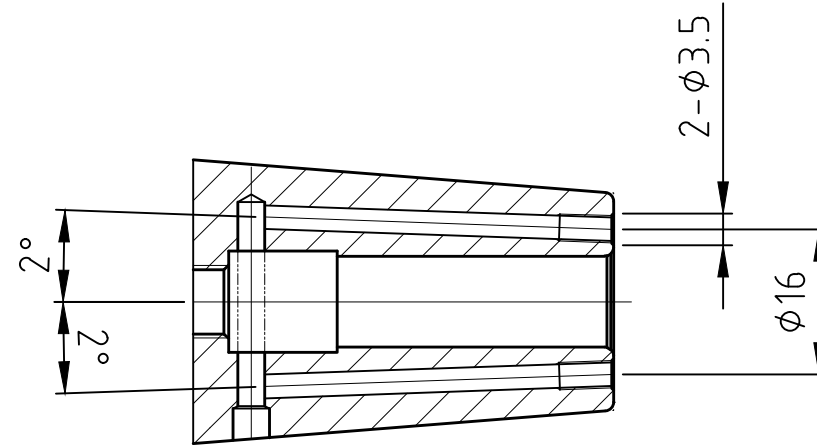

SECTION A'-A

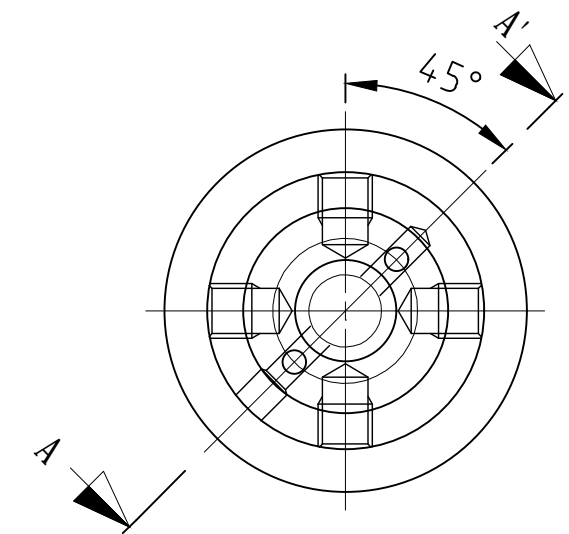
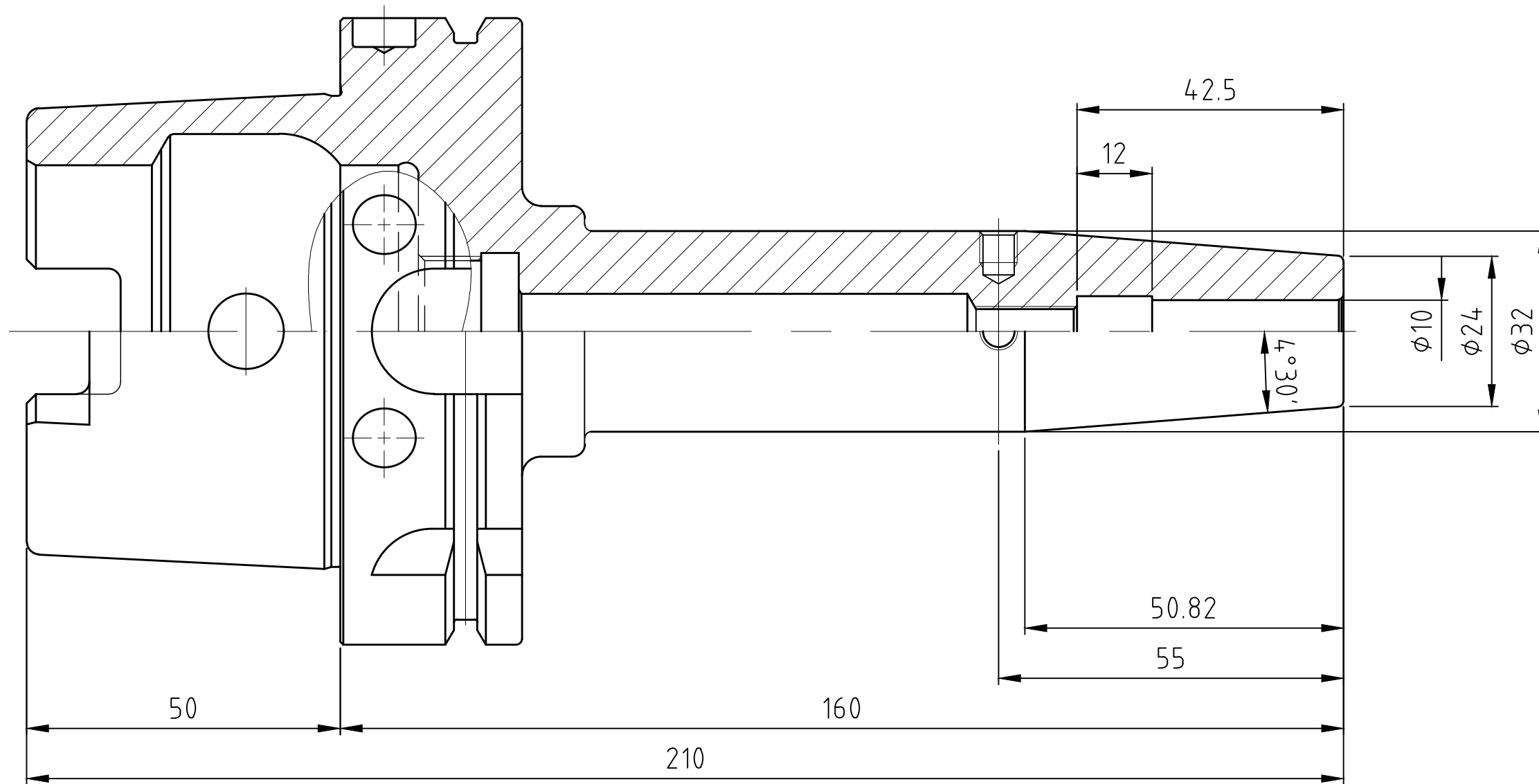
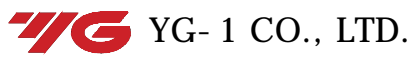

	DESCRIPTION	
	HSK100A-SFH10CR-160	
	EDP No.	VR116JR
	SCALE	1 : 1