

NO.	REVISIONS	DATE	DEVISER
1.			
2.			
3.			

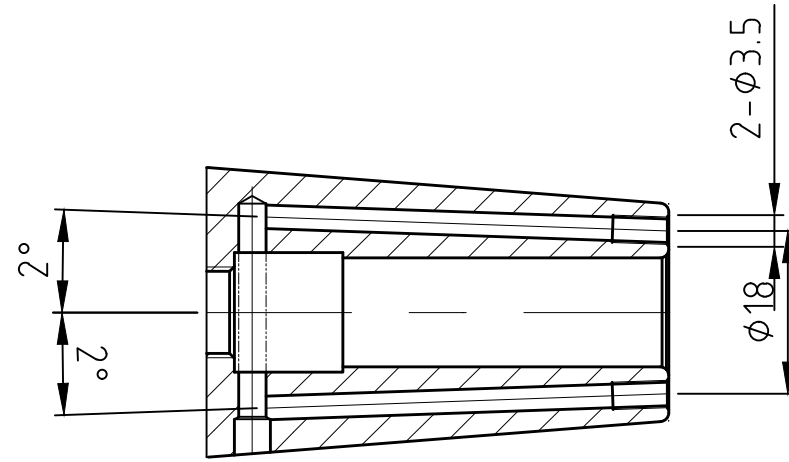

SECTION A' - A

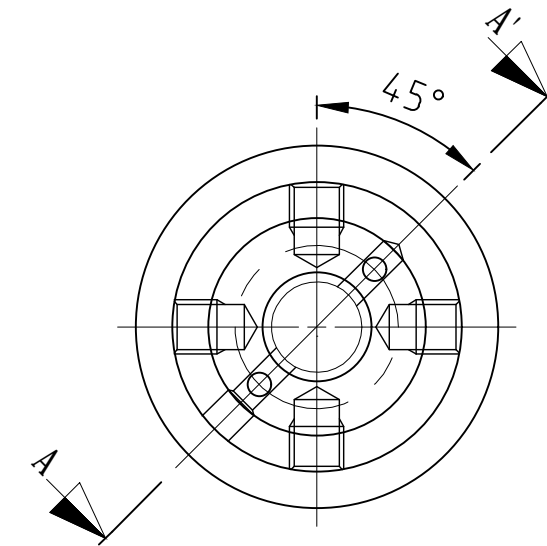
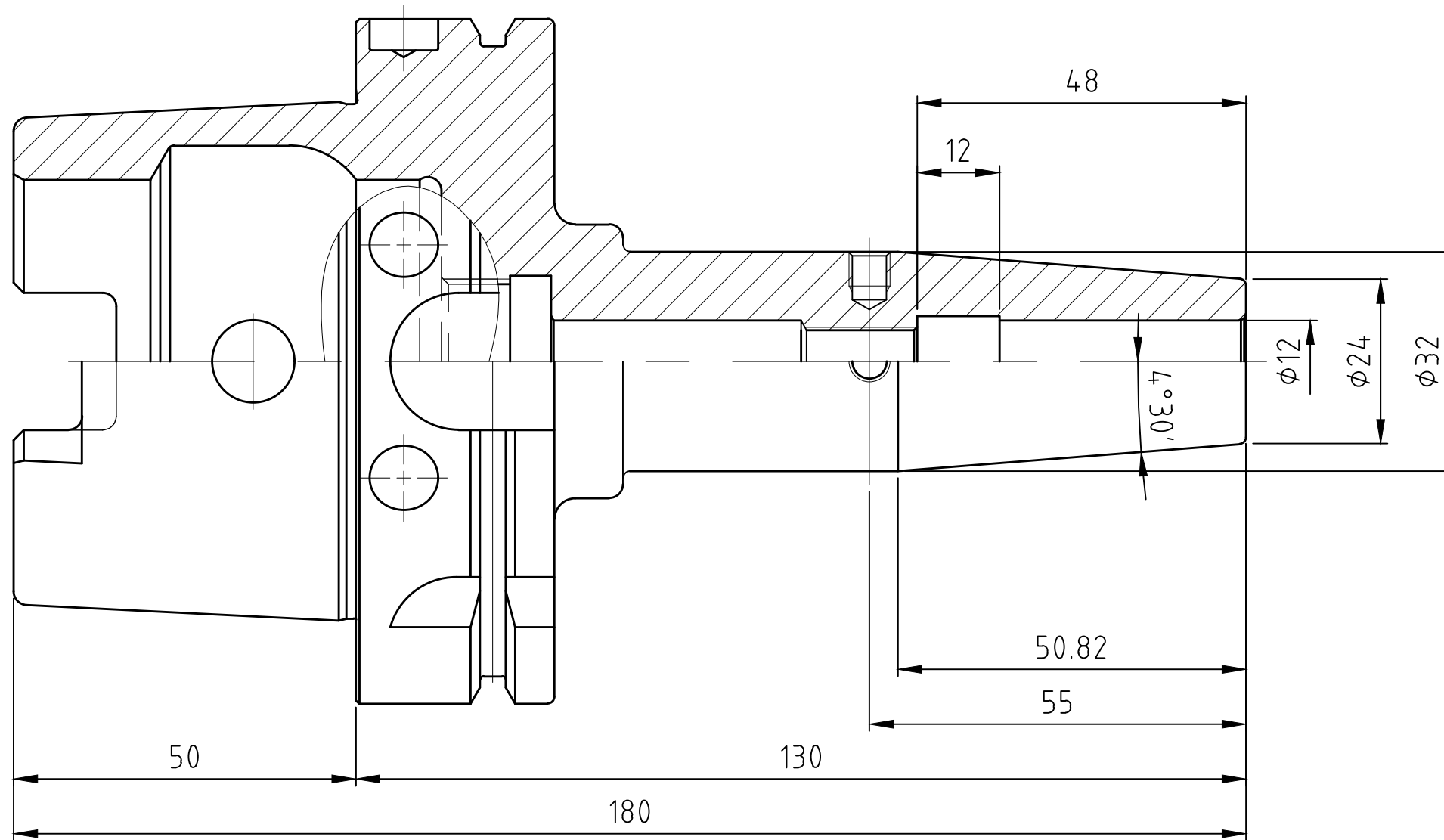
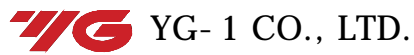

	DESCRIPTION	
	HSK100A-SFH12CR-130	
	EDP No.	VR104JR SCALE 1:1