

NO.	REVISIONS	DATE	DEVISER
1.			
2.			
3.			

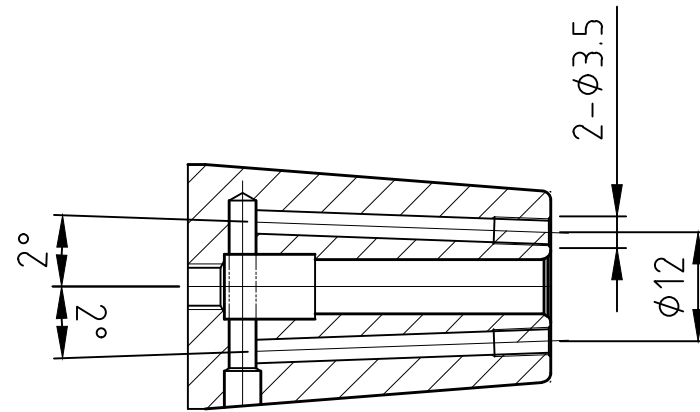

SECTION A' - A

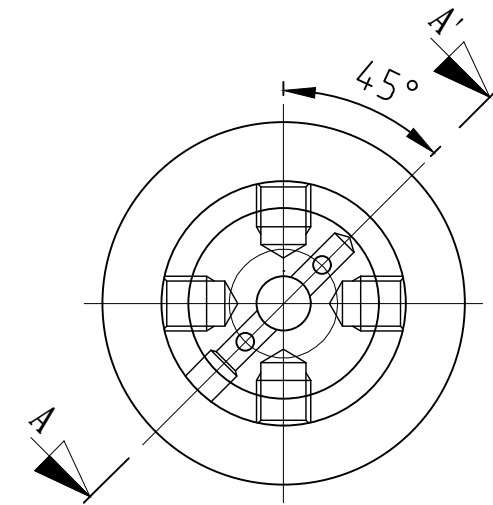
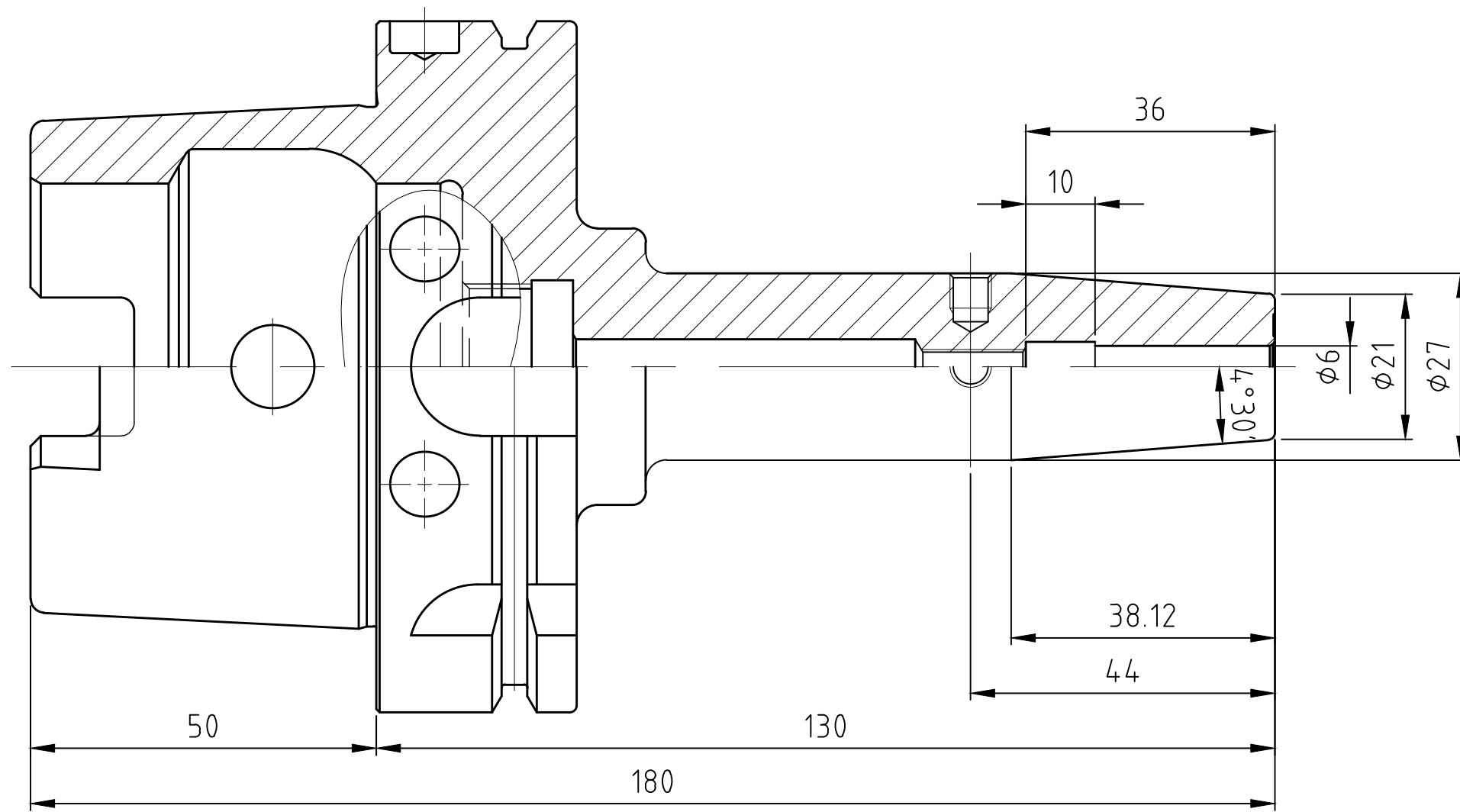
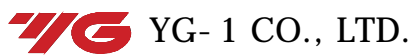

	DESCRIPTION		
	HSK100A-SFH6CR-130		
	EDP No.	VR101JR	SCALE 1:1