

NO.	REVISIONS	DATE	DEVISER
1.			
2.			
3.			

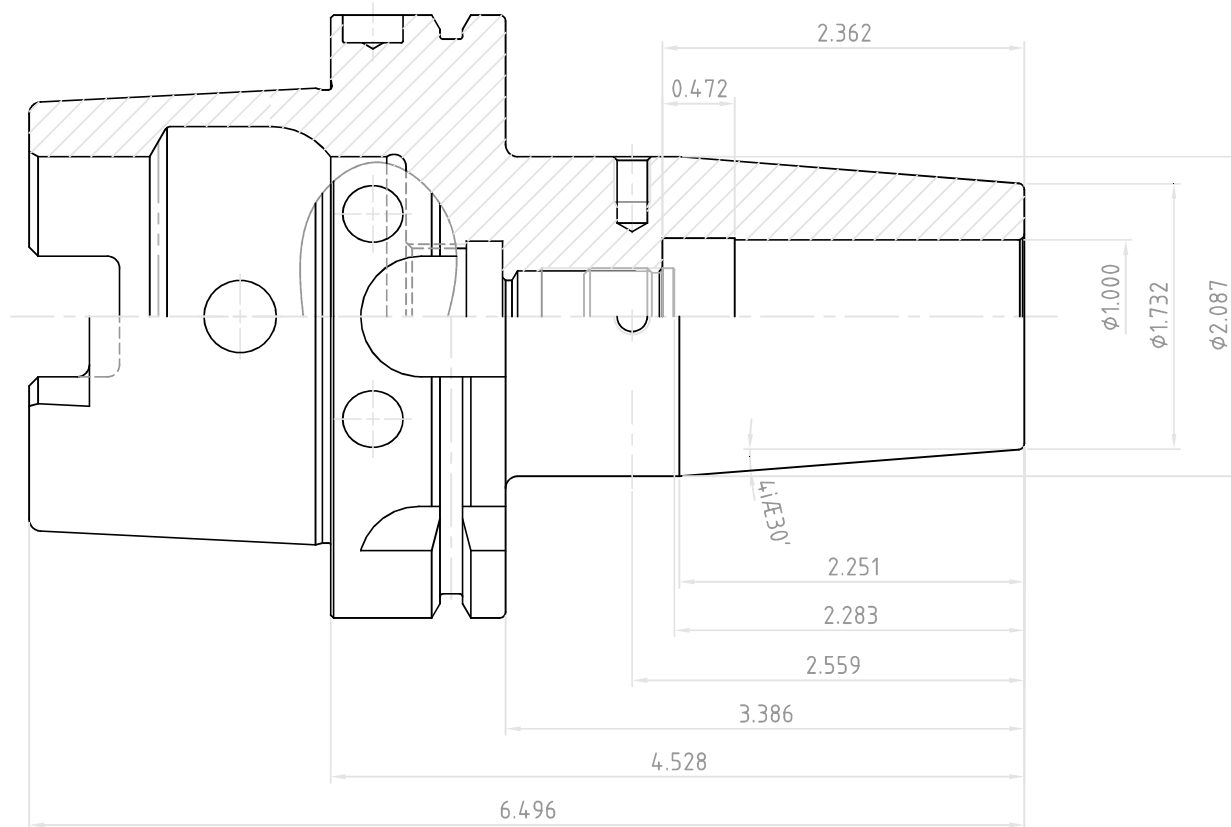

 YG-1 CO., LTD.	SSK CONTROL NUMBER		
	HSK100A-SFH1.000(25.4)-4.528(115)		
	EDP No.	VR040	SCALE 1 : 1