

NO.	REVISIONS	DATE	DEVISER
1.			
2.			
3.			

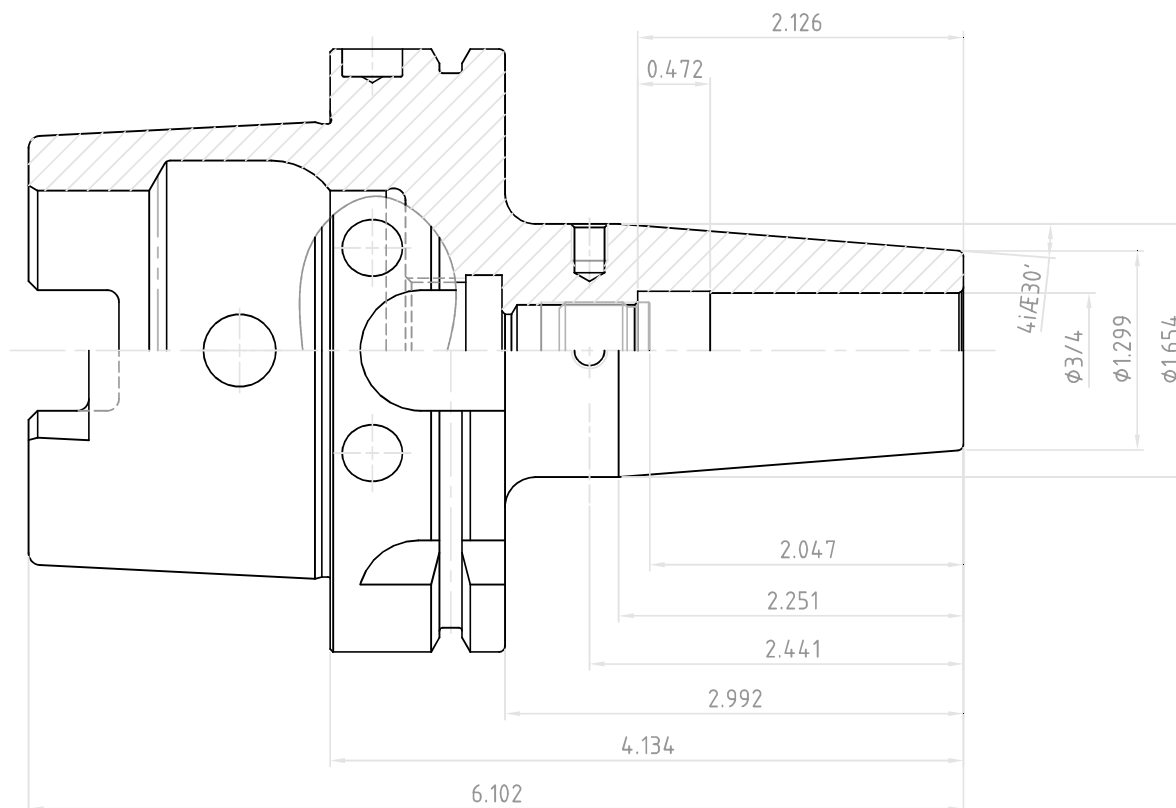

 YG-1 CO., LTD.	SSK CONTROL NUMBER		
	HSK100A-SFH3/4(19.050)-4.134(105)		
EDP No.	VR036	SCALE	1 : 1