

NO.	REVISIONS	DATE	DEVISER
1.			
2.			
3.			

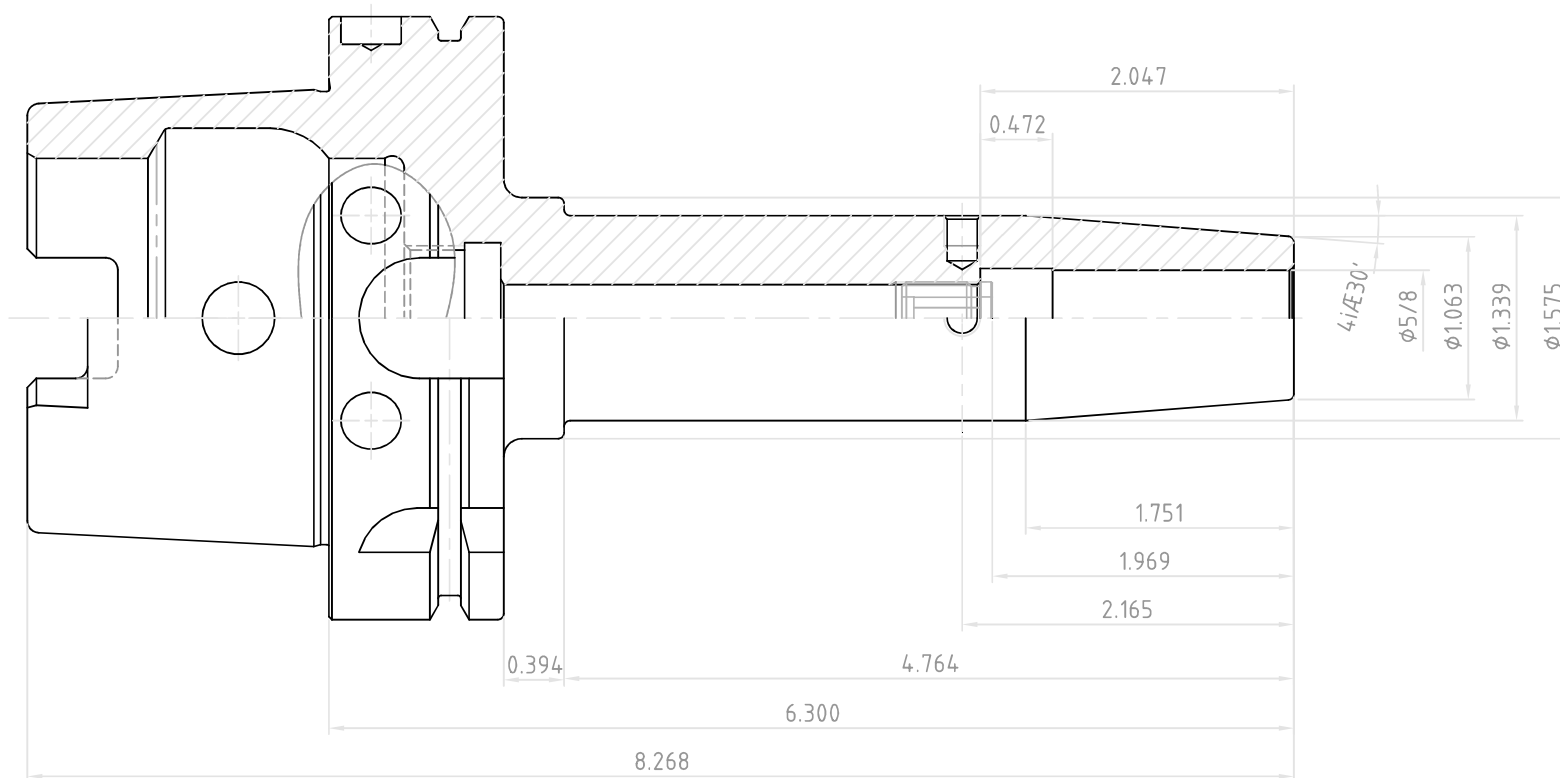

 YG-1 CO., LTD.	SSK CONTROL NUMBER		
	HSK100A-SFH5/8(15.875)-6.300(160)		
EDP No.	VR034	SCALE	1 : 1