

NO.	REVISIONS	DATE	DEVISER
1.			
2.			
3.			

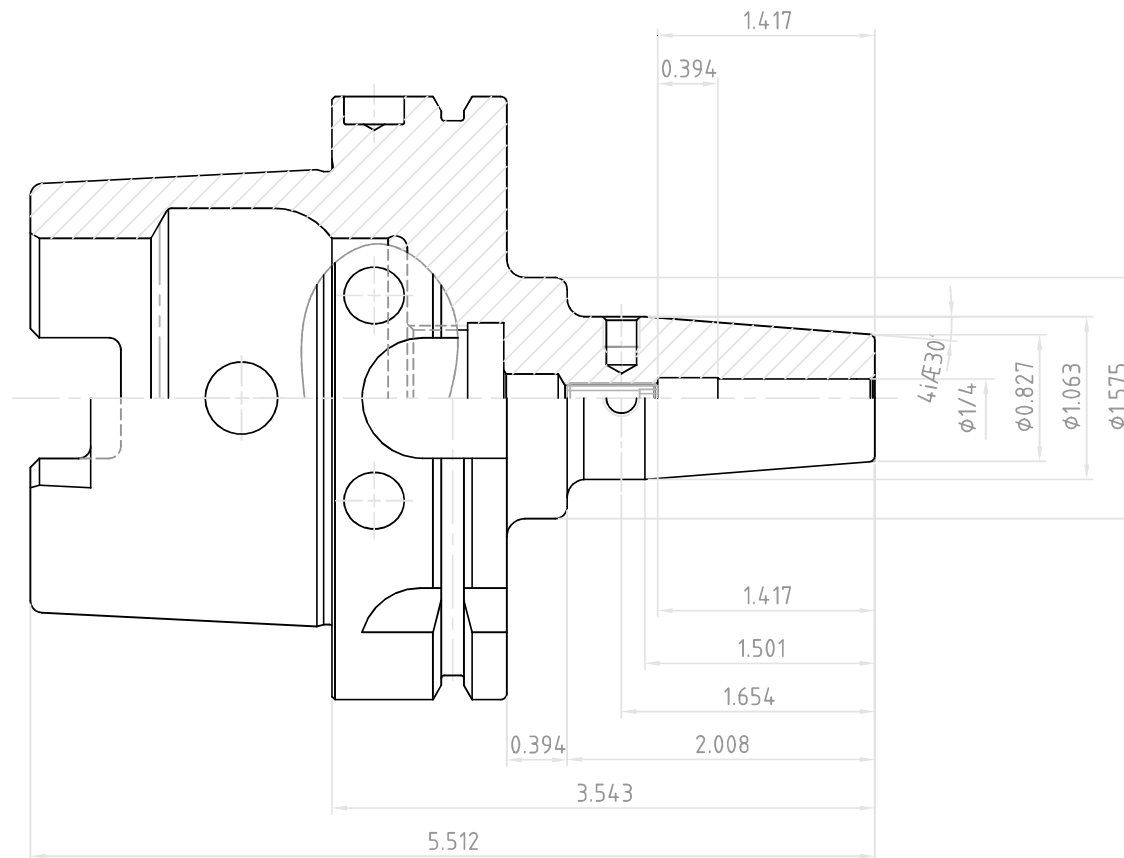

 YG-1 CO., LTD.	SSK CONTROL NUMBER	
	HSK100A-SFH1/4(6.350)-3.543(90)	
EDP No.	VR023	SCALE 1 : 1