

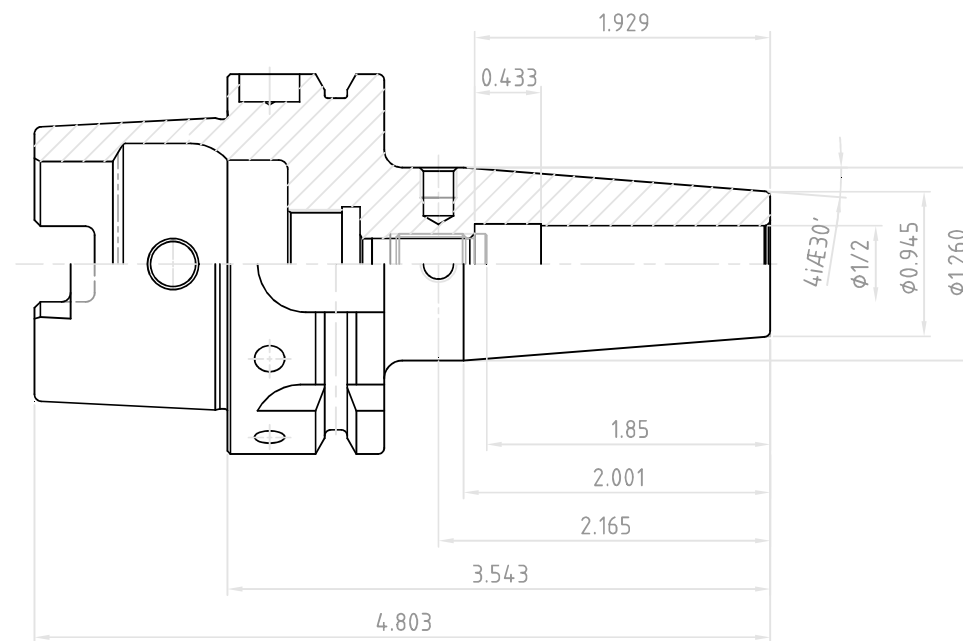

NO.	REVISIONS	DATE	DEVISER
1.			
2.			
3.			



 YG-1 CO., LTD.	SSK CONTROL NUMBER	
	HSK63A-SFH1/2(12.700)-3.543(90)	
EDP No.	VQ032	SCALE 1 : 1