

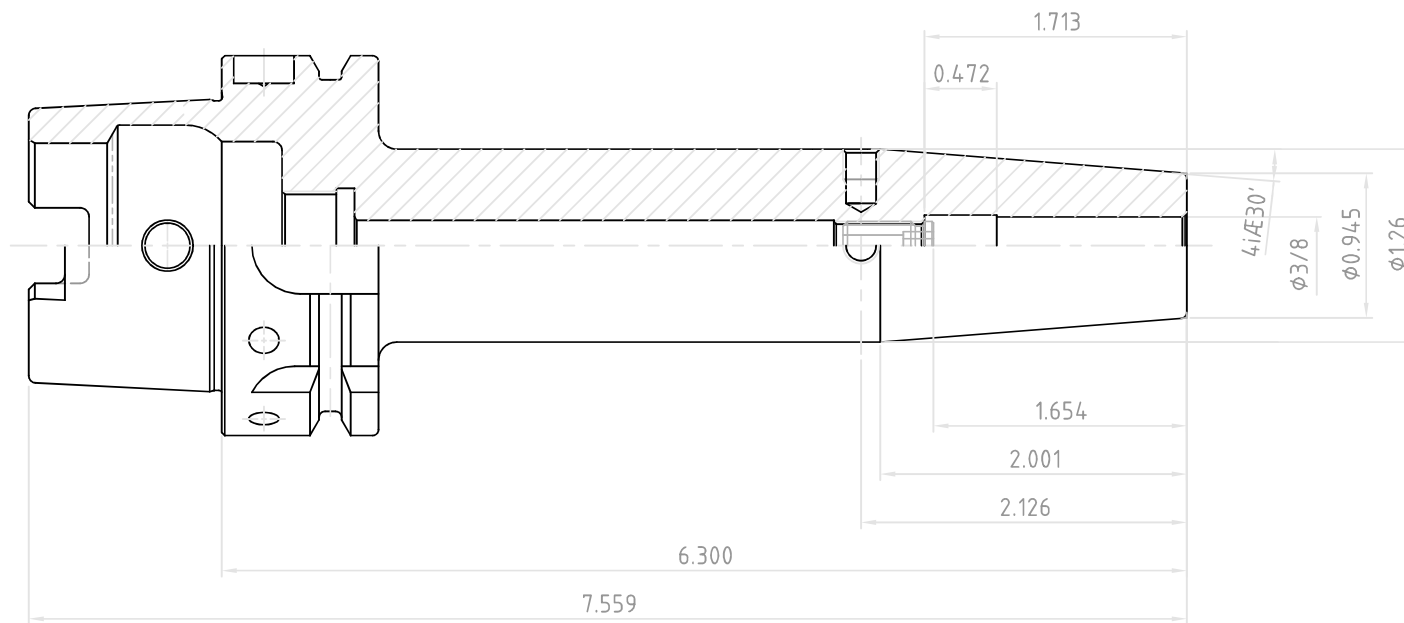

NO.	REVISIONS	DATE	DEVISER
1.			
2.			
3.			



 YG-1 CO., LTD.	SSK CONTROL NUMBER	
	HSK63A-SFH3/8(9.525)-6.300(160)	
EDP No.	VQ030	SCALE 1 : 1