

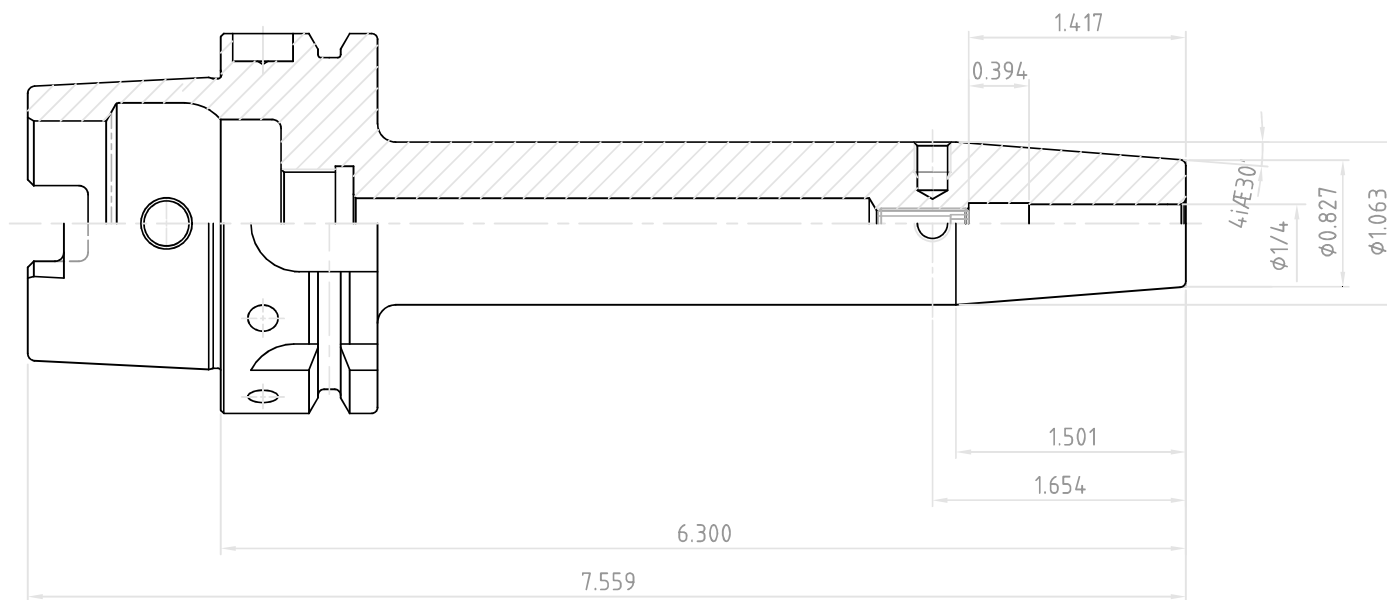

NO.	REVISIONS	DATE	DEVISER
1.			
2.			
3.			



 YG-1 CO., LTD.	SSK CONTROL NUMBER		
	HSK63A-SFH1/4(6.350)-6.300(160)		
	EDP No.	VQ026	SCALE 1 : 1