

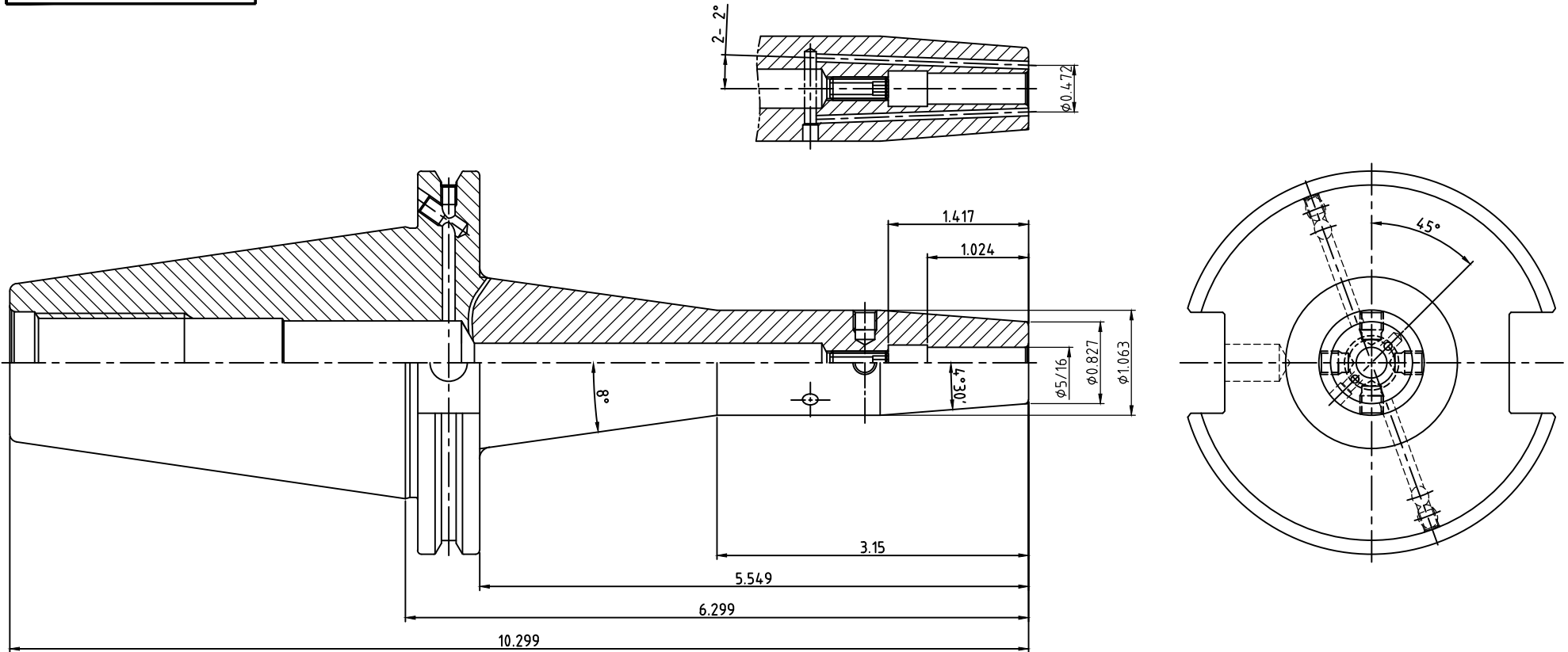

NO.	REVISIONS	DATE	DEVISER
1.			
2.			
3.			

APPROVAL
DATE
SIGNATURE



 YG-1 CO., LTD.	DESCRIPTION		
	CAT50AD/B-SFH5/16(7.93)CTW-6.30(160)		
	EDP No.	VL060JTW	SCALE 1 : 1