

NO.	REVISIONS	DATE	DEVISER
1.			
2.			
3.			

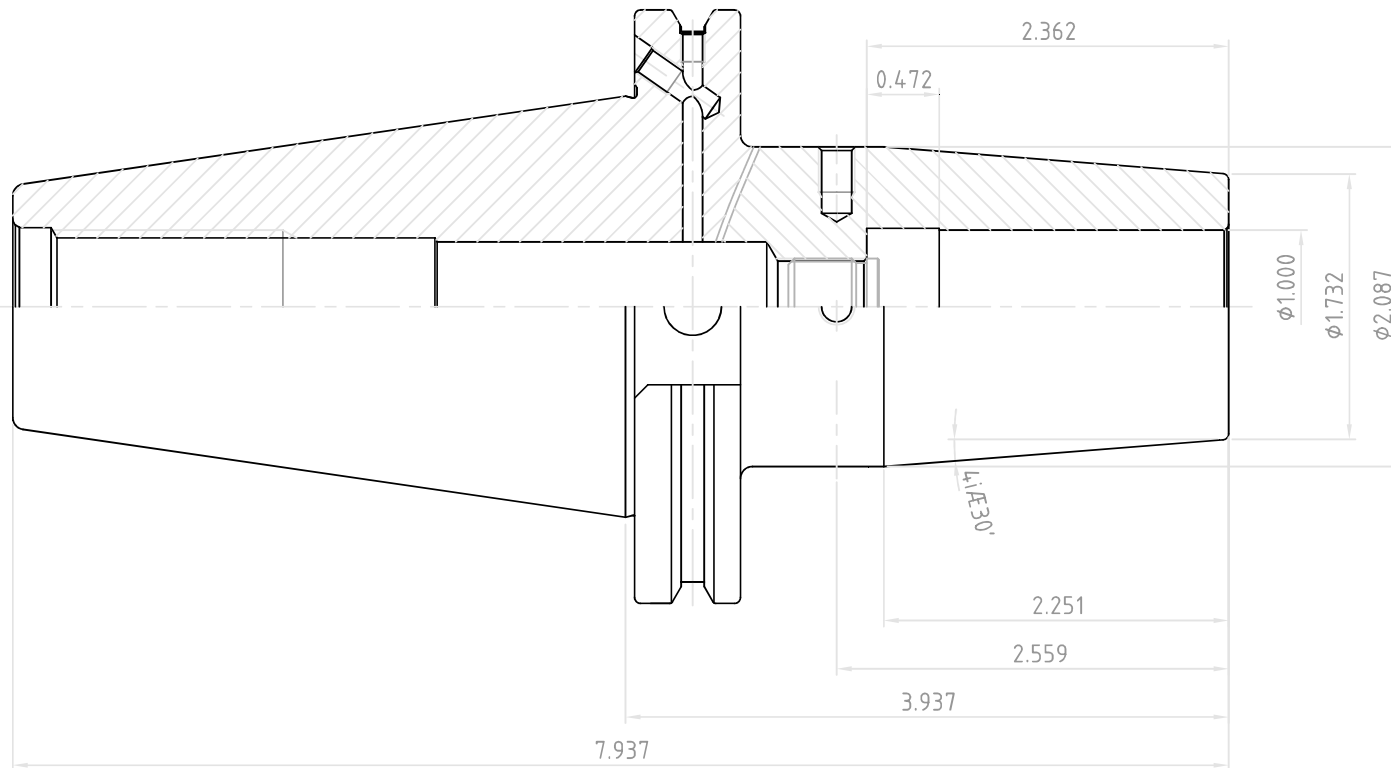

 YG-1 CO., LTD.	SSK CONTROL NUMBER	
	CCT50AD/B-SFH1.000(25.4)-3.937(100)	
EDP No.	VC046	SCALE 1 : 1