

NO.	REVISIONS	DATE	DEVISER
1.			
2.			
3.			

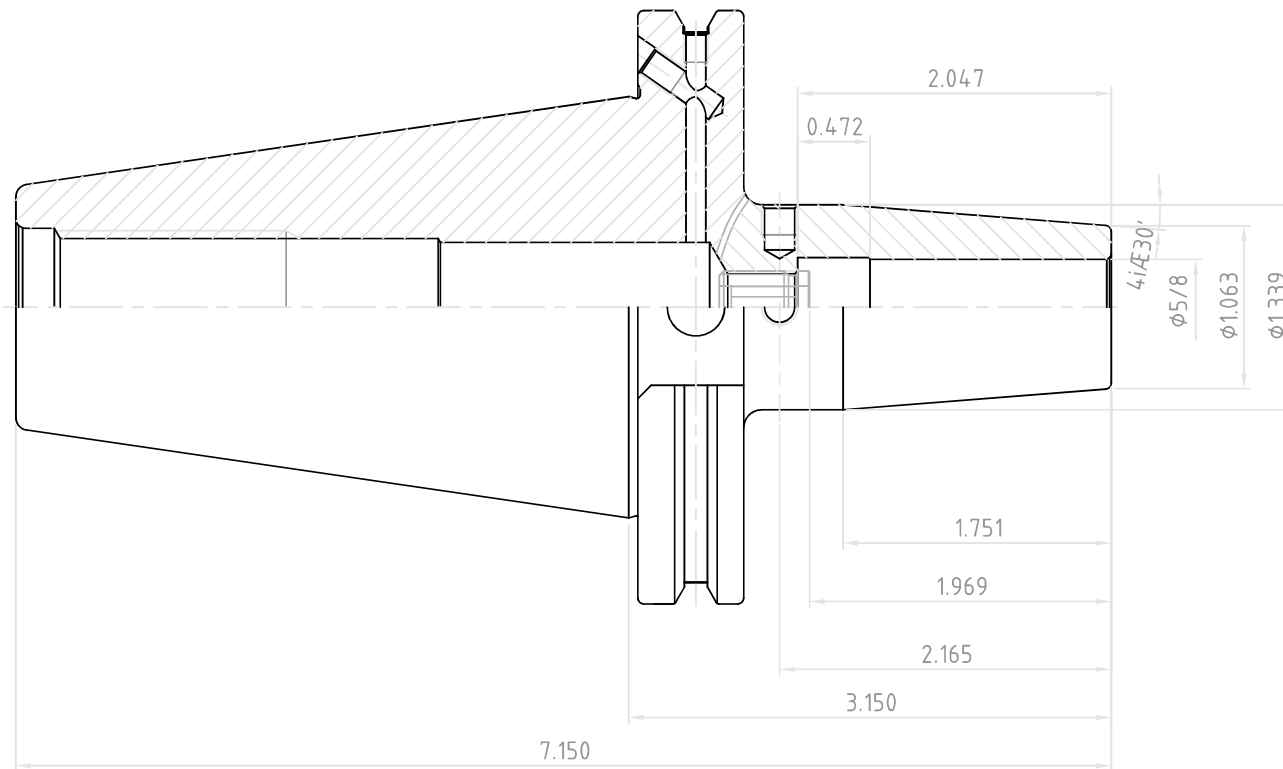

 YG-1 CO., LTD.	SSK CONTROL NUMBER	
	CCT50AD/B-SFH5/8(15.875)-3.150(80)	
EDP No.	VC036	SCALE 1 : 1