

NO.	REVISIONS	DATE	DEVISER
1.			
2.			
3.			

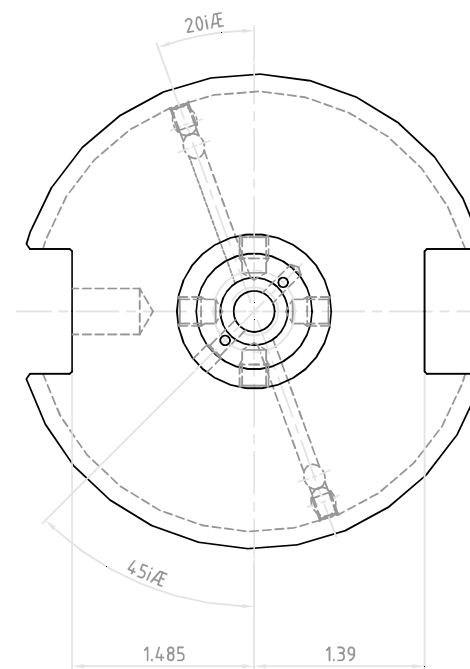
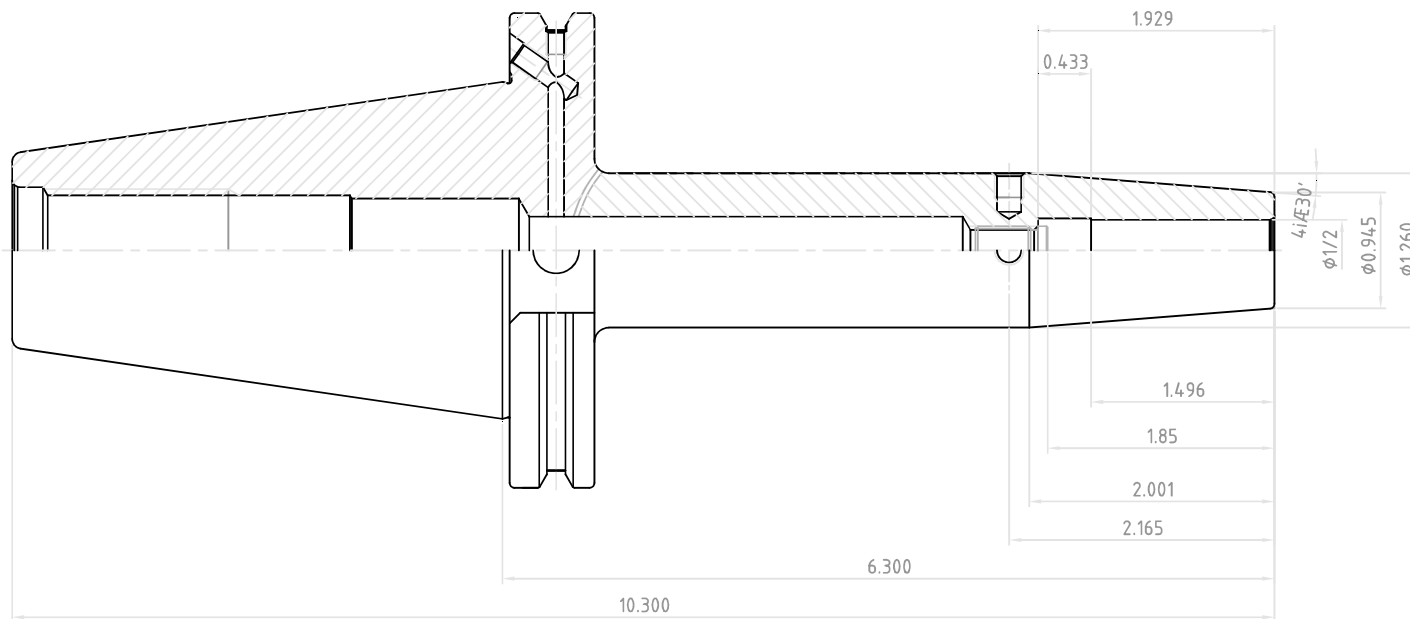
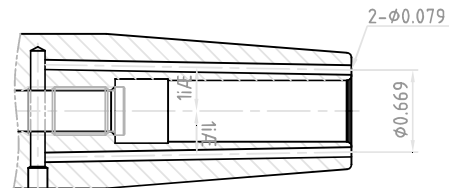

 YG-1 CO., LTD.	SSK CONTROL NUMBER		
	CCT50AD/B-SFH1/2(12.70)C-6.30(160)		
	EDP No.	VC034J	SCALE 1 : 1