

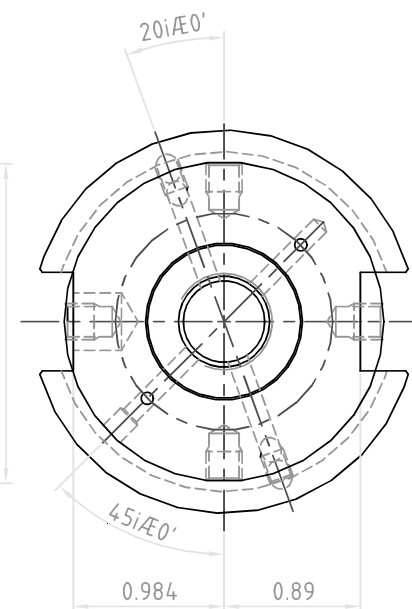

NO.	REVISIONS	DATE	DEVISER
1.			
2.			
3.			

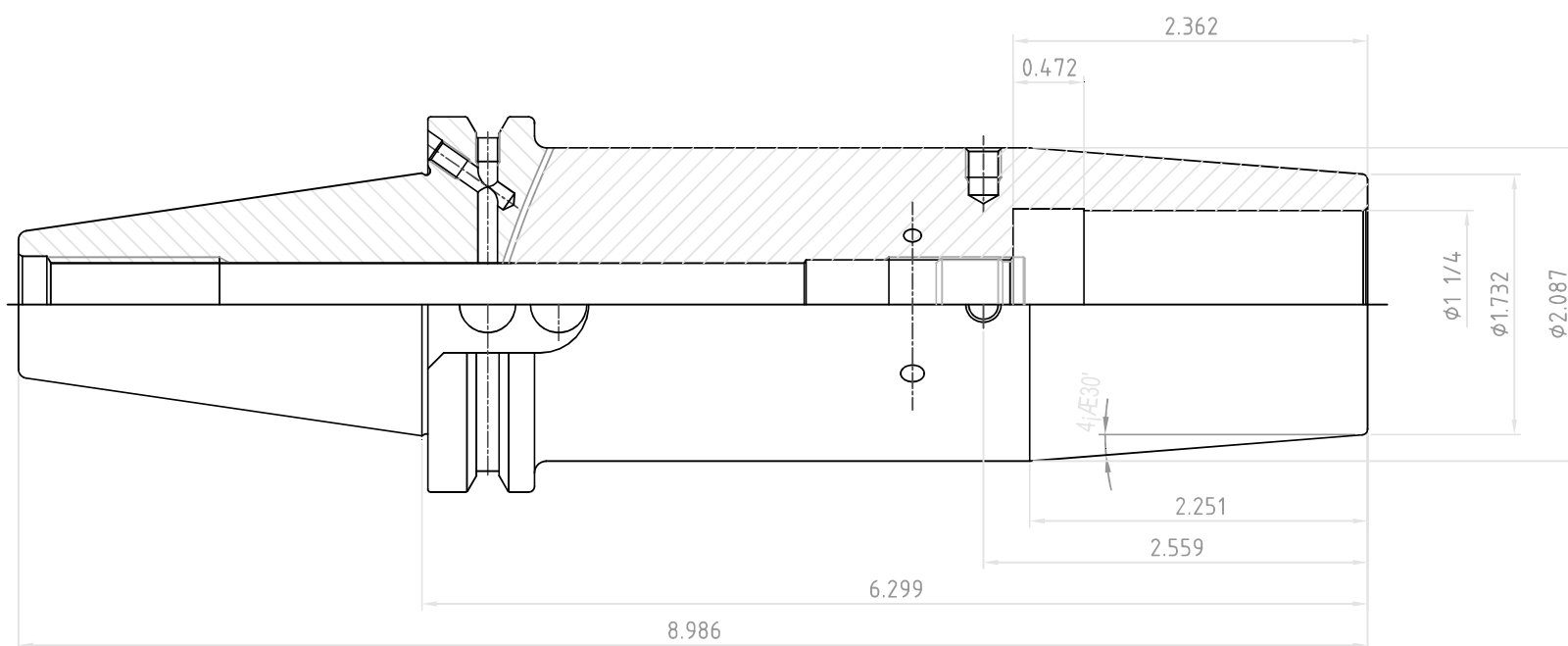
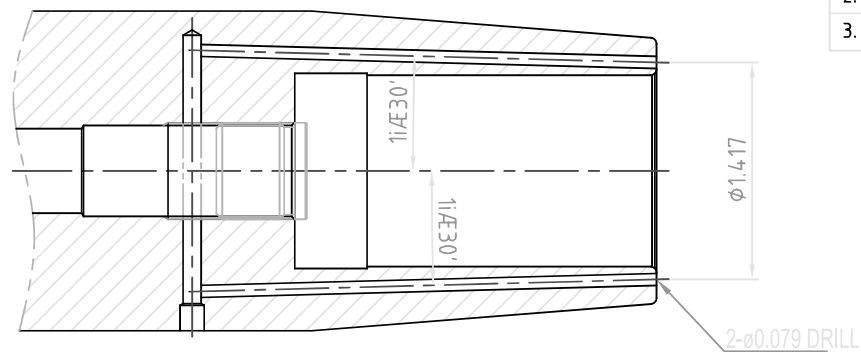

 YG-1 CO., LTD.	SSK CONTROL NUMBER	
	CCT40AD/B-SFH1 1/4(31.750)C-6.30(160)	
	EDP No.	VB050J
	SCALE	1 : 1