

NO.	REVISIONS	DATE	DEVISER
1.			
2.			
3.			

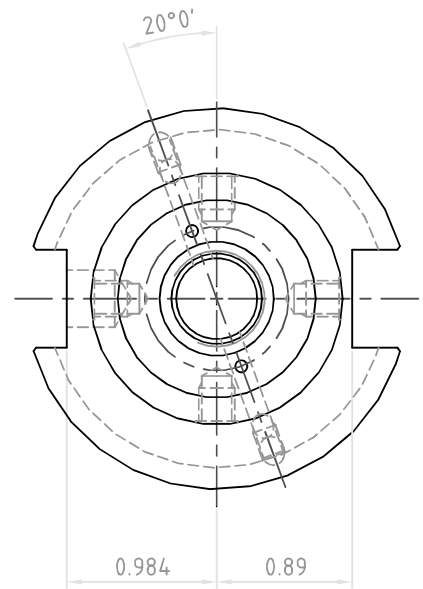
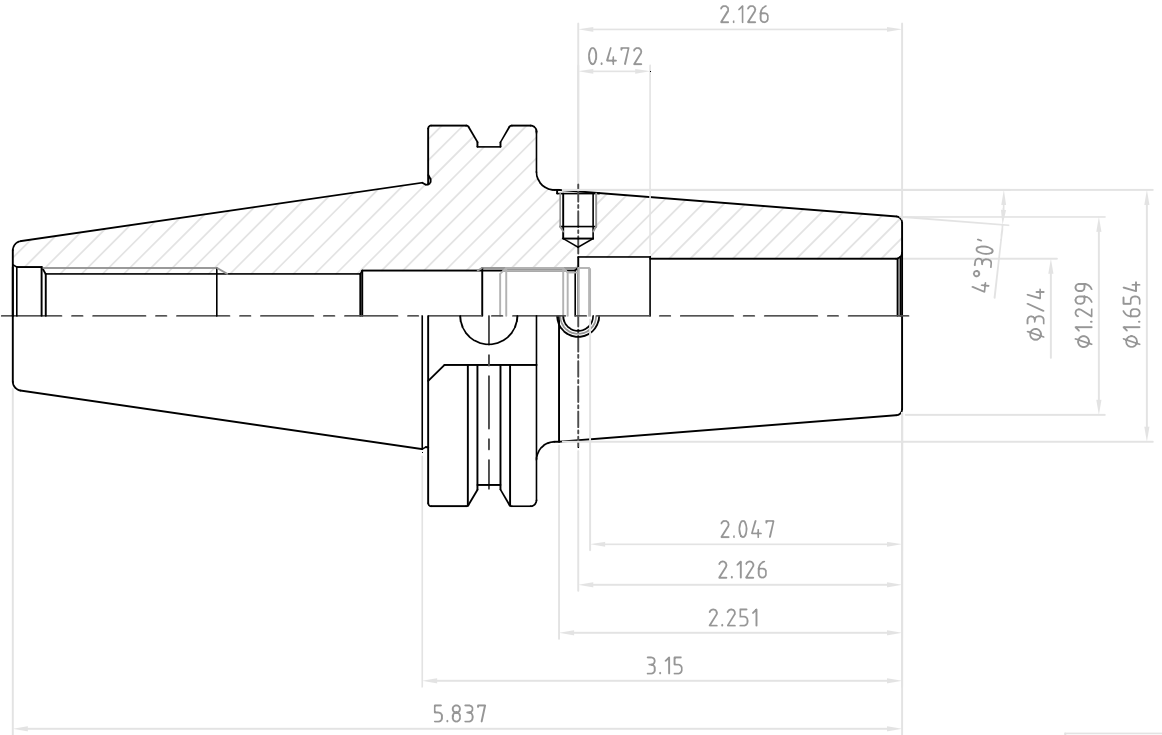
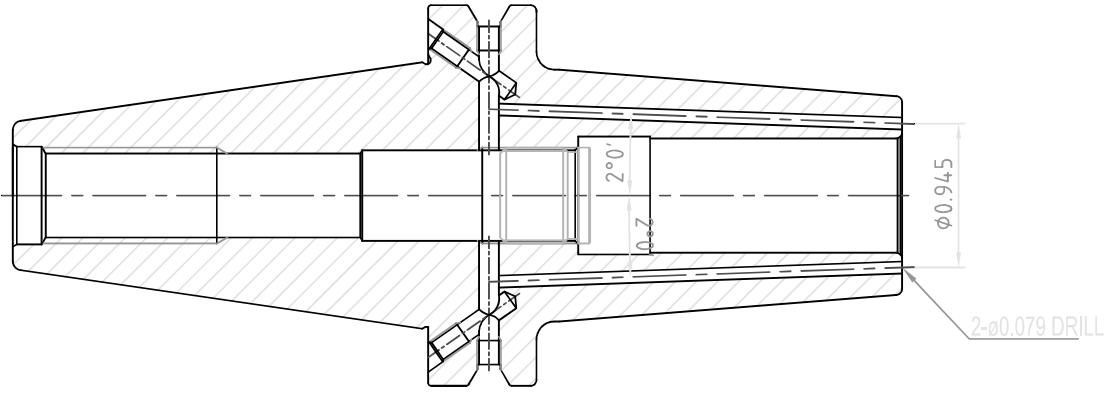

 YG-1 CO., LTD.	SSK CONTROL NUMBER		
	CCT40AD/B-SFH3/4(19.050)C-3.150(160)		
	EDP No.	VB040J	SCALE 1 : 1