

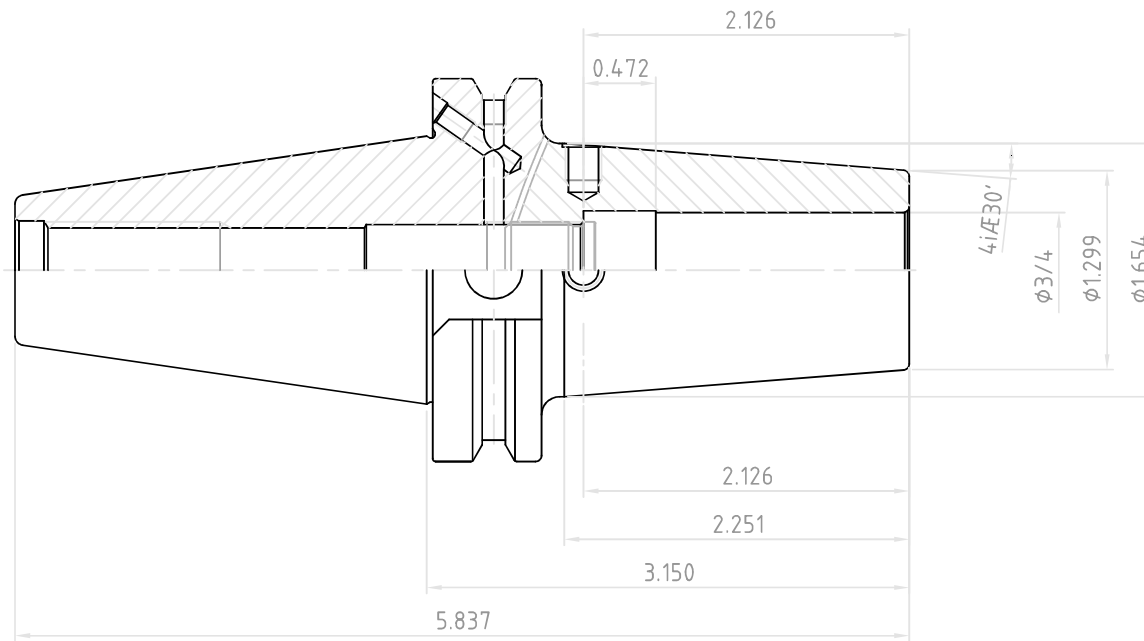

NO.	REVISIONS	DATE	DEVISER
1.			
2.			
3.			



 <b>YG-1 CO., LTD.</b>	SSK CONTROL NUMBER	
	CCT40AD/B-SFH3/4(19.050)-3.150(80)	
	EDP No.	VB040
		SCALE 1 : 1