

NO.	REVISIONS	DATE	DEVISER
1.			
2.			
3.			

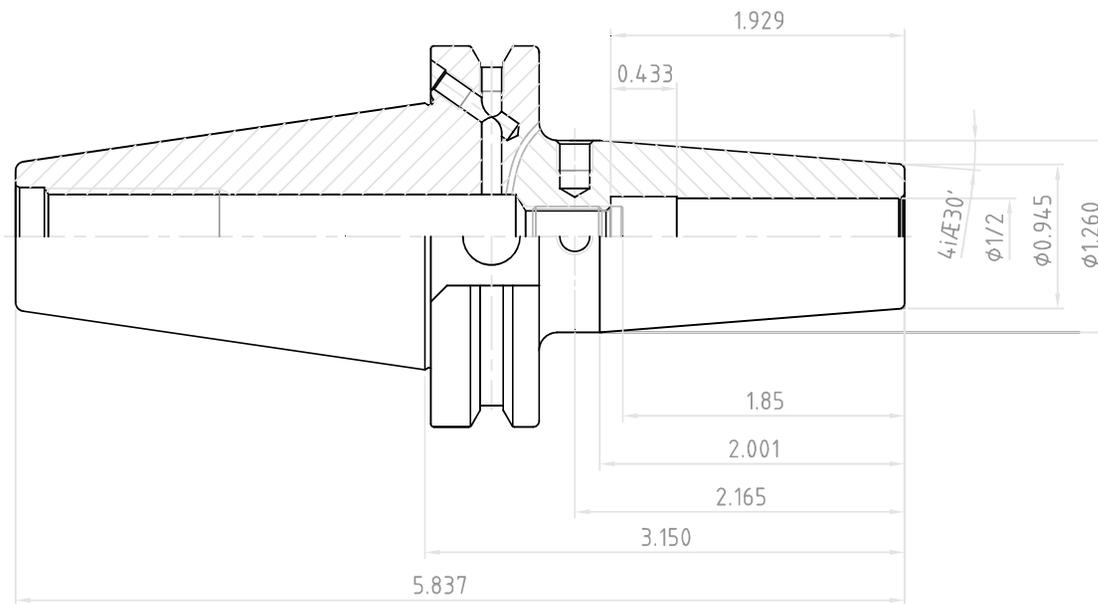

 YG-1 CO., LTD.	SSK CONTROL NUMBER	
	CCT40AD/B-SFH1/2(12.700)-3.150(80)	
	EDP No.	VB032
	SCALE	1 : 1