

NO.	REVISIONS	DATE	DEVISER
1.			
2.			
3.			

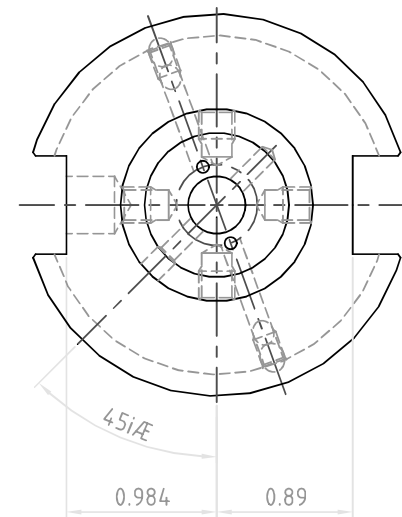
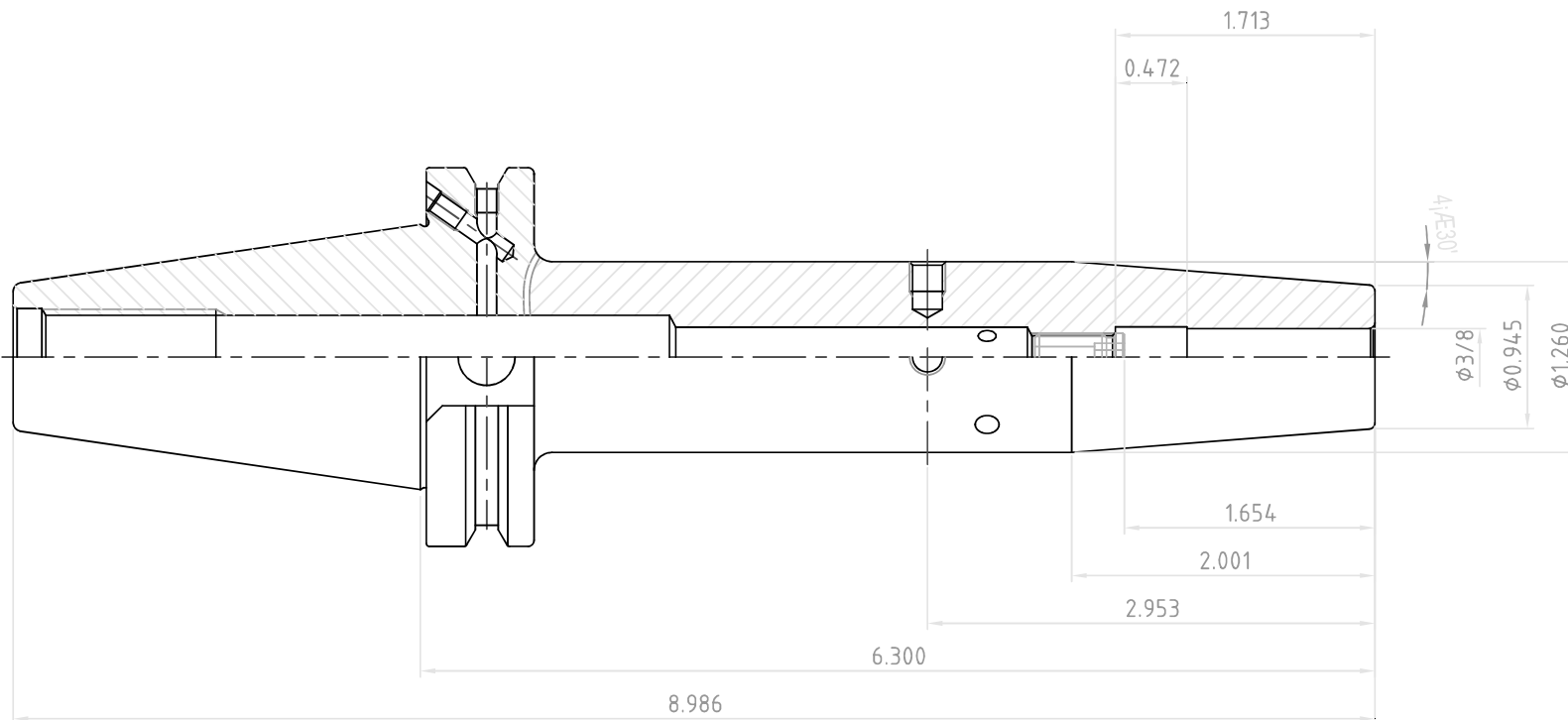
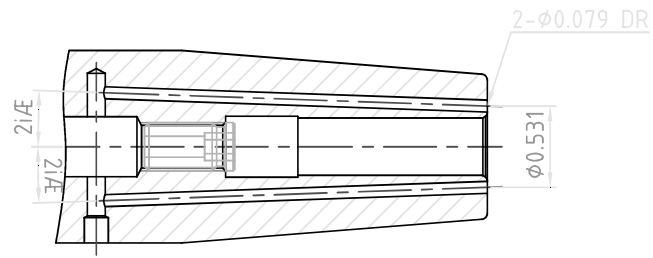

	SSK CONTROL NUMBER		
	CCT40AD/B-SFH3/8(9.525)C-6.300(160)		
EDP No.	VB030J	SCALE	1 : 1