

NO.	REVISIONS	DATE	DEVISER
1.			
2.			
3.			

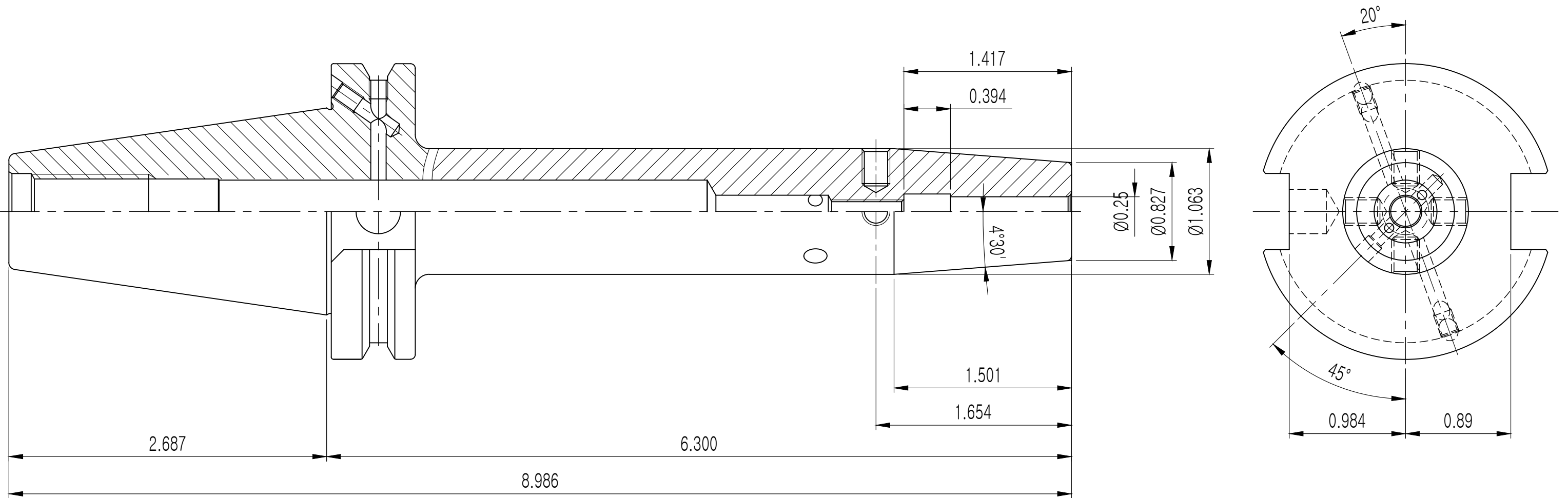
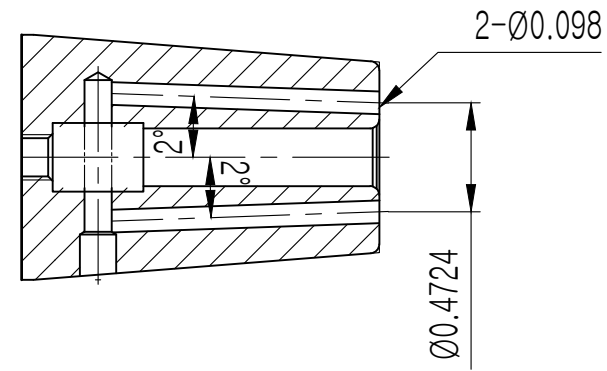

SSK CONTROL NUMBER		
CCT40AD/B-SFH1/4(6.350)C-6.300(160)		
EDP No.	VB026J	SCALE 1 : 1