

NO.	REVISIONS	DATE	DEVISER
1.			
2.			
3.			

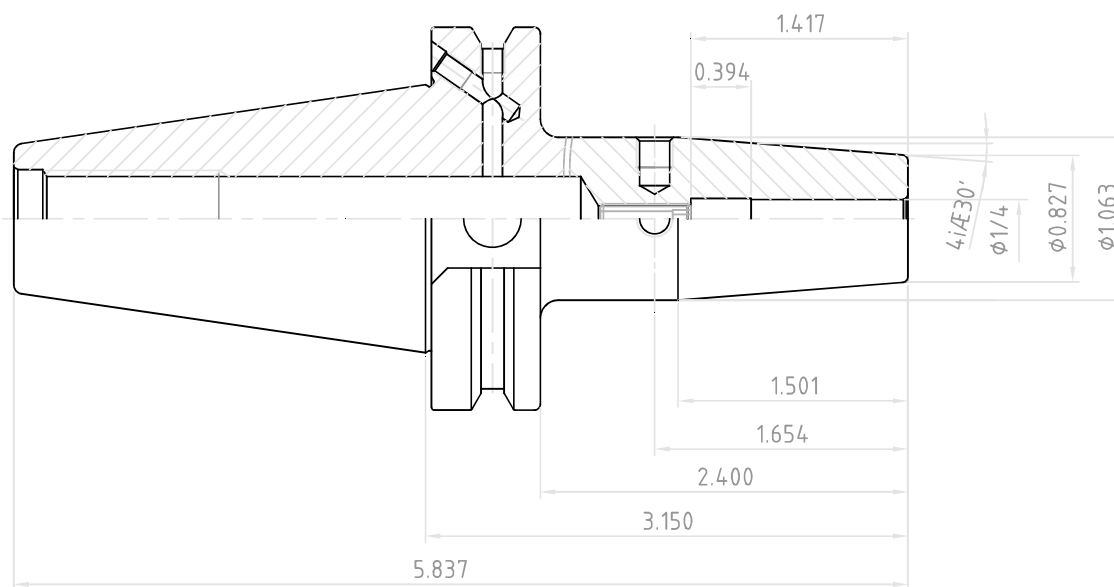

 YG-1 CO., LTD.	SSK CONTROL NUMBER	
	CCT40AD/B-SFH1/4(6.350)-3.150(80)	
EDP No.	VB024	SCALE 1 : 1