

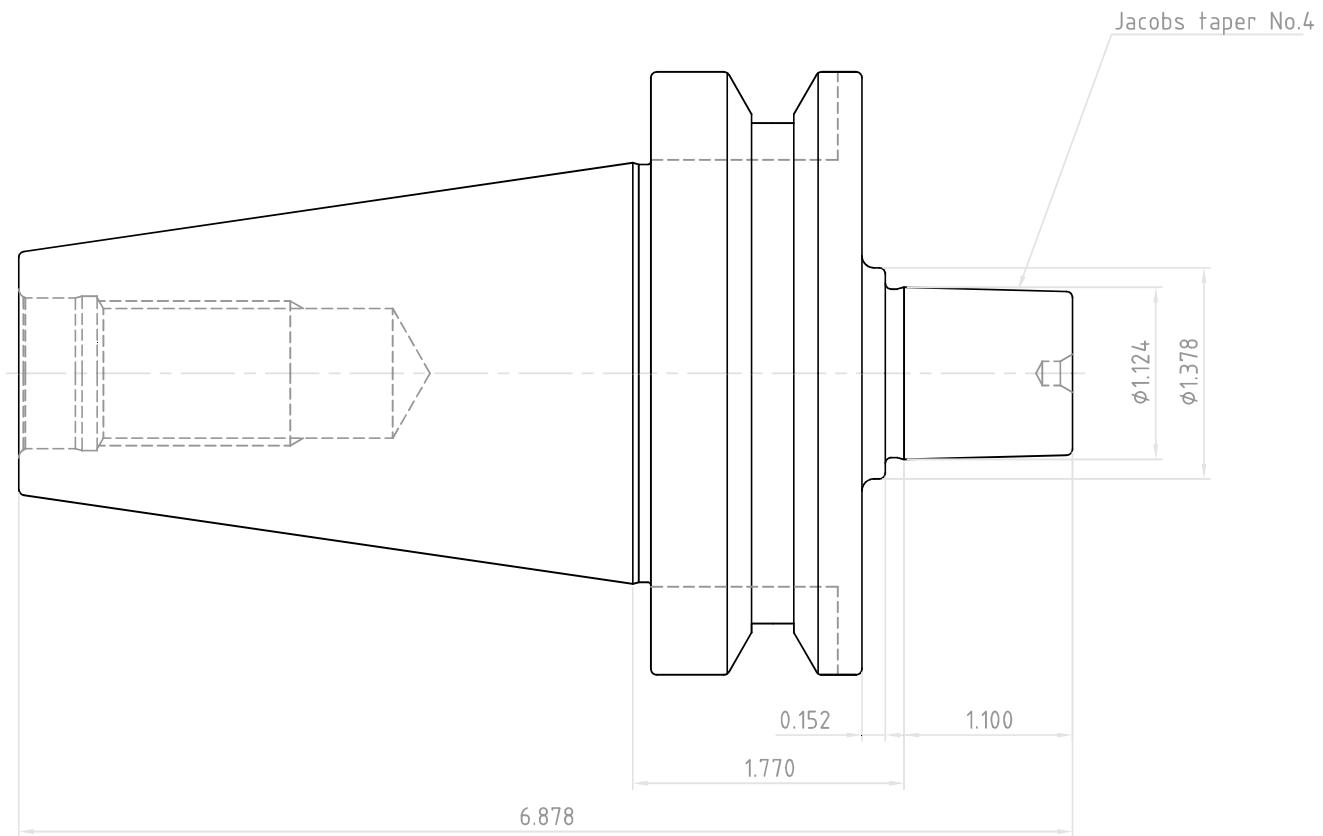

NO.	REVISIONS	DATE	DEVISER
1.			
2.			
3.			



 YG-1 CO., LTD.	DESCRIPTION		
	BT50-JTA4-1.77(44.96)		
EDP No.	GI045	SCALE	1 : 1