

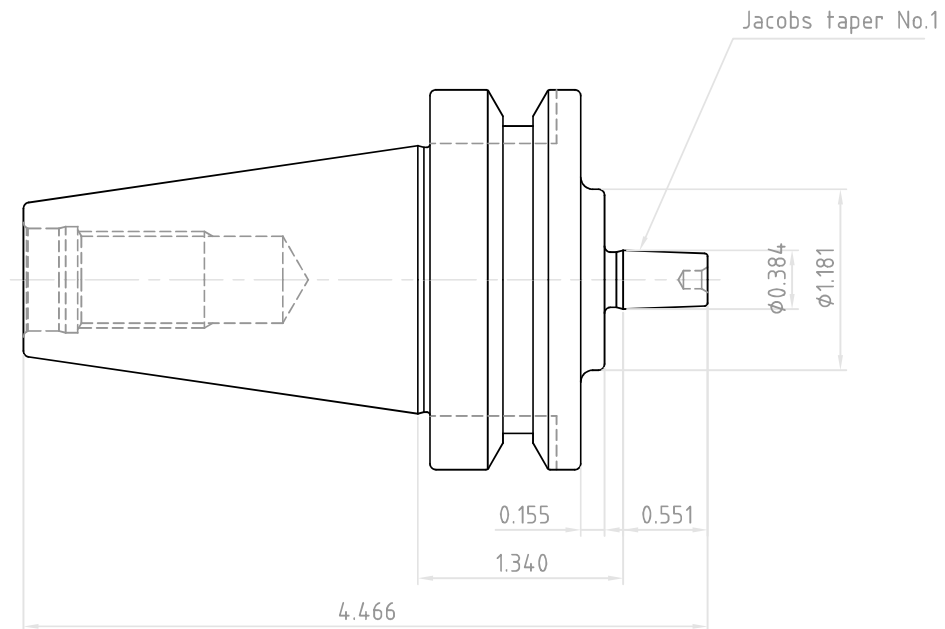

NO.	REVISIONS	DATE	DEVISER
1.			
2.			
3.			



 YG-1 CO., LTD.	DESCRIPTION		
	BT40-JTA1-1.34(34.04)		
	EDP No.	GH042	SCALE 1 : 1