

NO.	REVISIONS	DATE	DEVISER
1.			
2.			
3.			

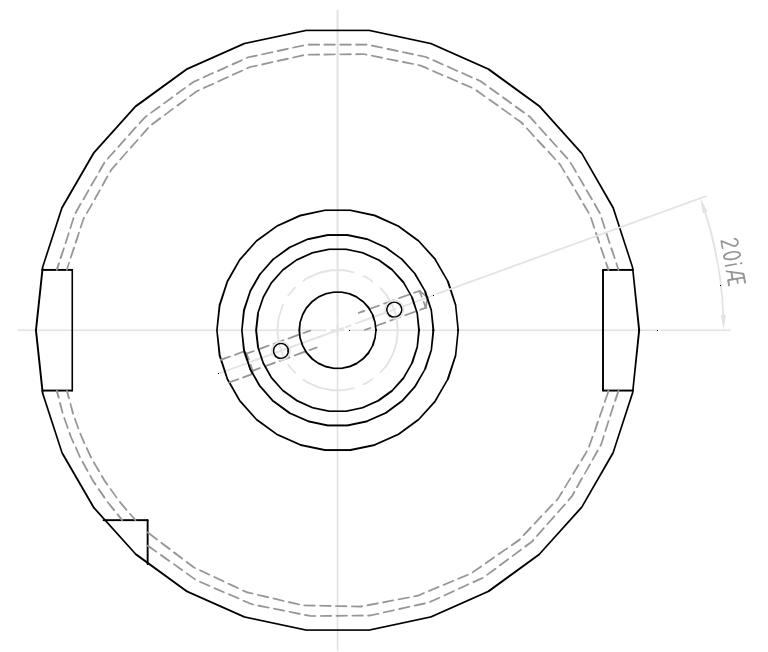
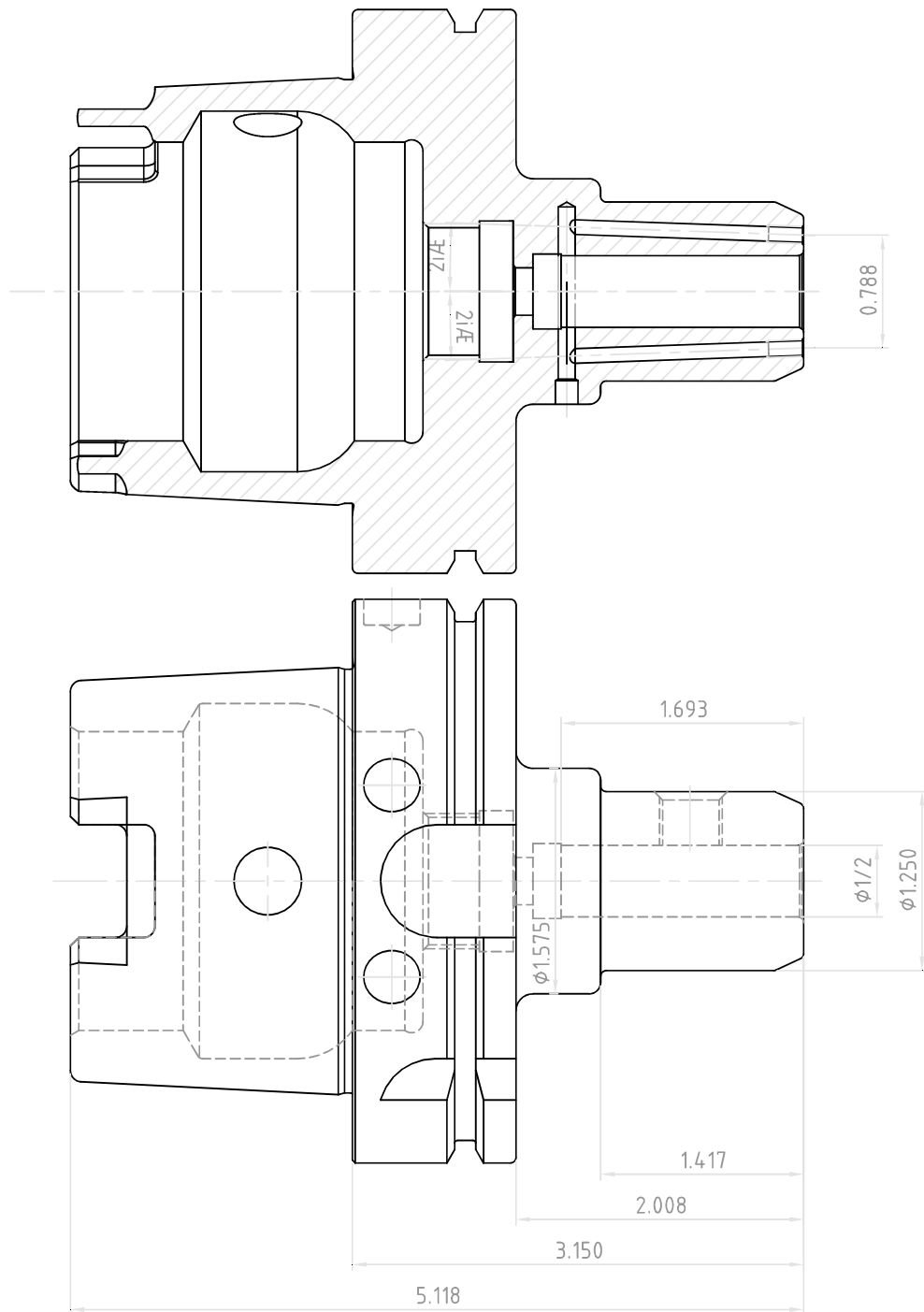

 YG-1 CO., LTD.	DESCRIPTION		
	HSK100A-EMH1/2(12.7)C-3.15(80)		
	EDP No.	AR026C	SCALE 1 : 1