

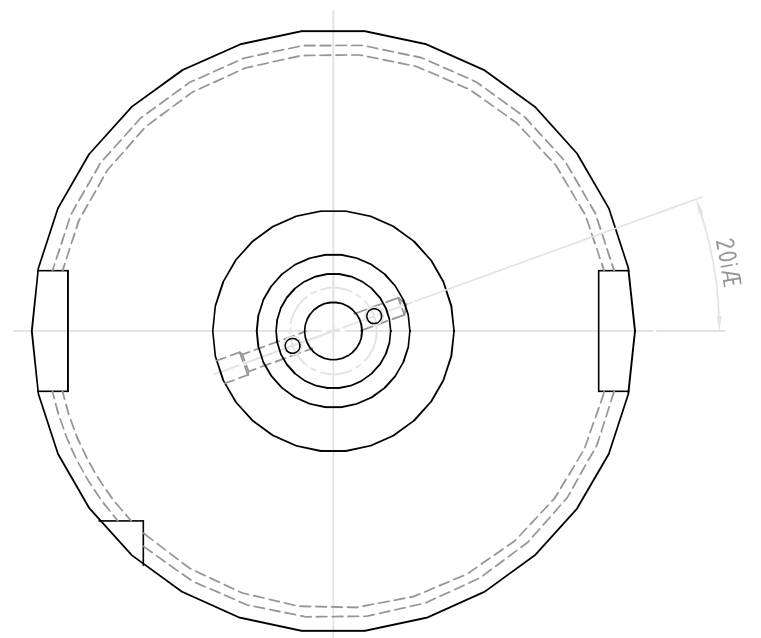

NO.	REVISIONS	DATE	DEVISER
1.			
2.			
3.			

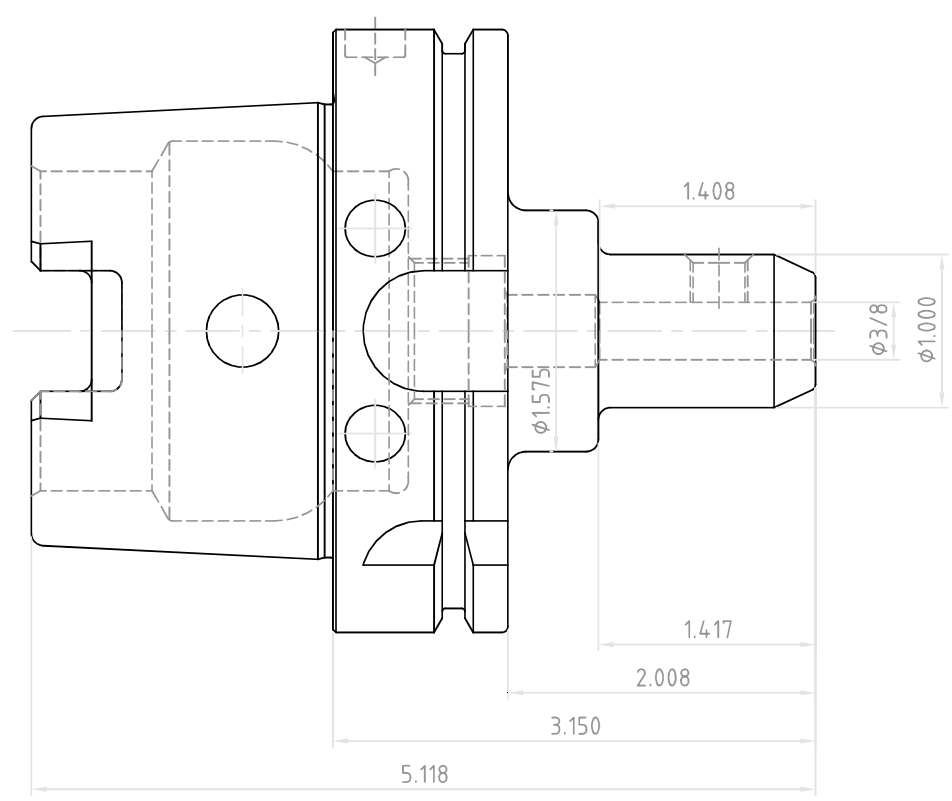
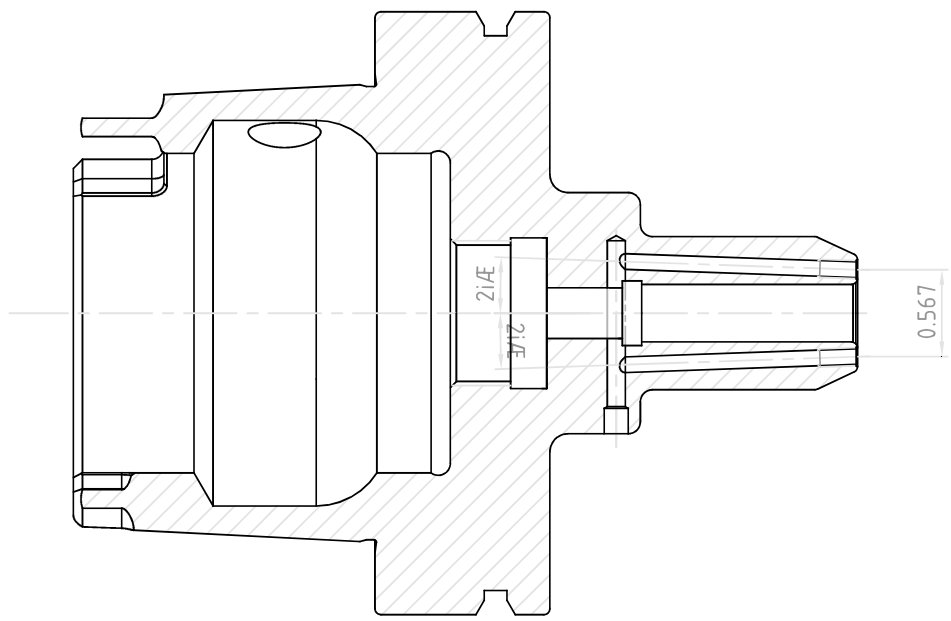

 YG-1 CO., LTD.	DESCRIPTION		
	HSK100A-EMH3/8(9.52)C-3.15(80)		
EDP No.	AR024C	SCALE	1 : 1