

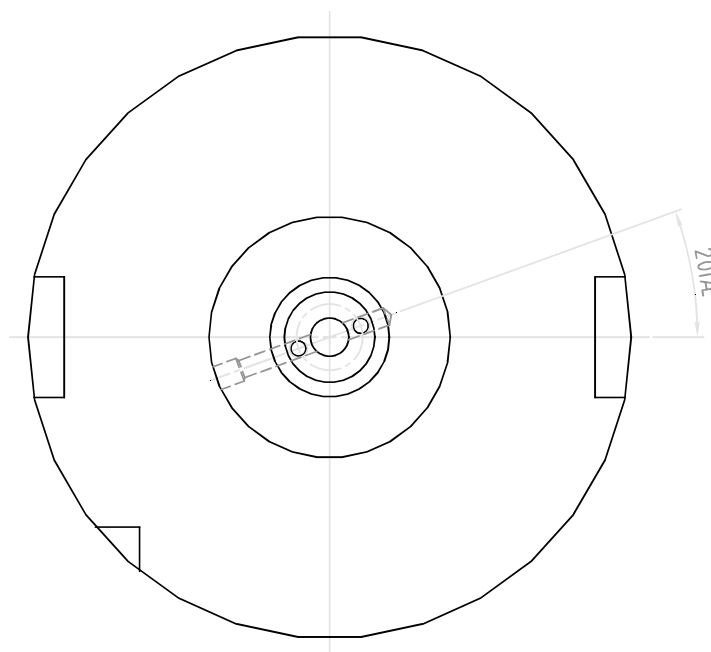

NO.	REVISIONS	DATE	DEVISER
1.			
2.			
3.			

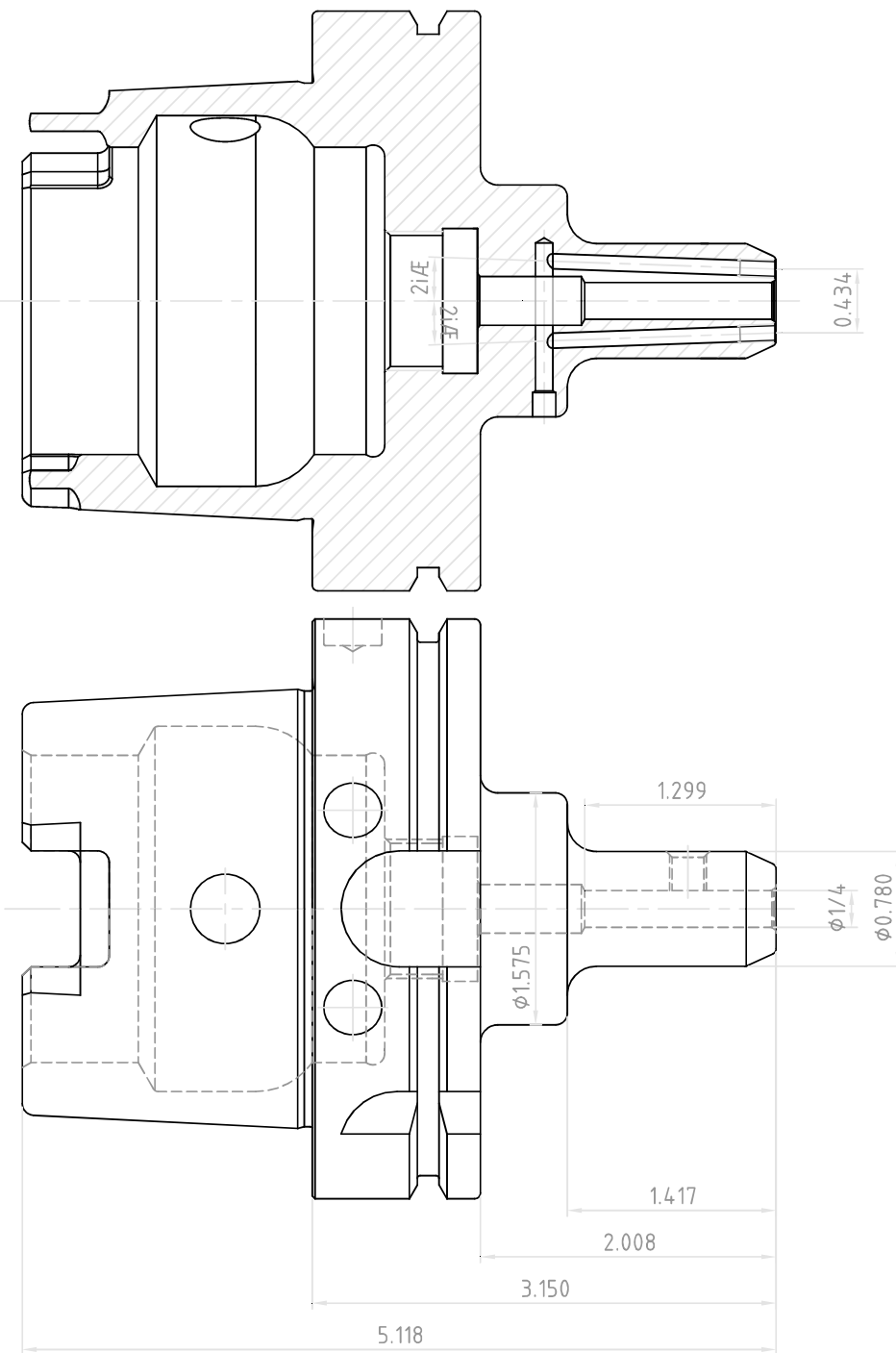

 YG-1 CO., LTD.	DESCRIPTION	
	HSK100A-EMH1/4(6.35)C-3.15(80)	
EDP No.	AR020C	SCALE 1 : 1