

NO.	REVISIONS	DATE	DEVISER
1.			
2.			
3.			

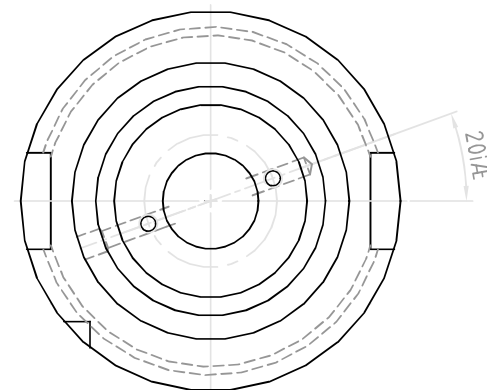
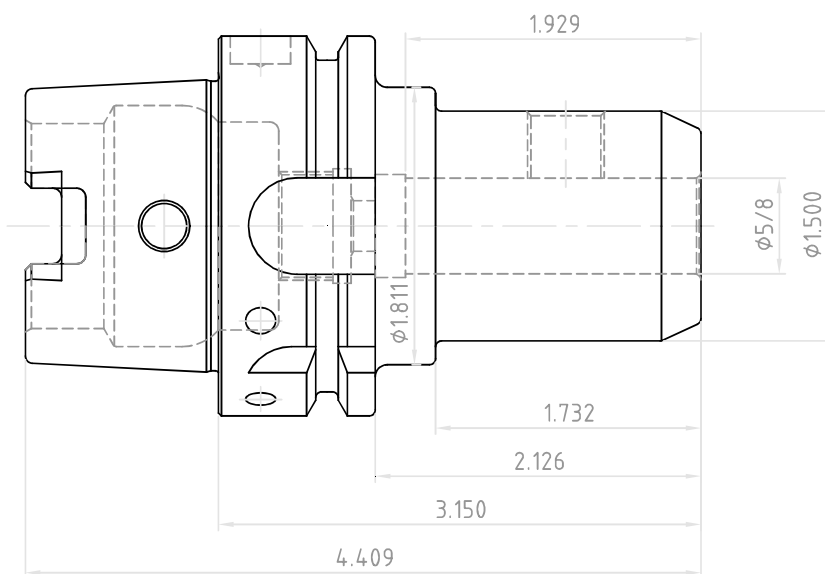
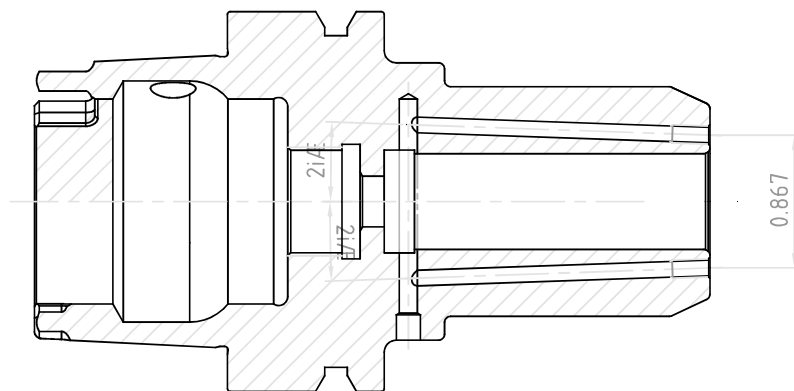

 YG-1 CO., LTD.	DESCRIPTION		
	HSK63A-EMH5/8(15.87)C-3.15(80)		
EDP No.	AQ028C	SCALE	1 : 1