

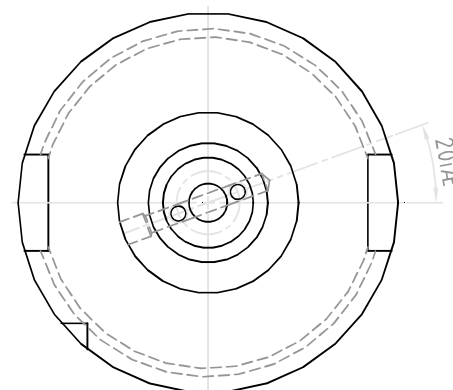

NO.	REVISIONS	DATE	DEVISER
1.			
2.			
3.			

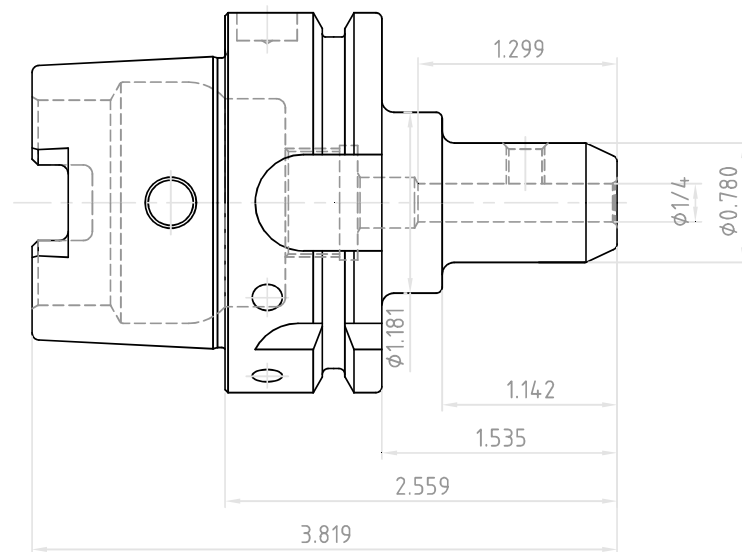
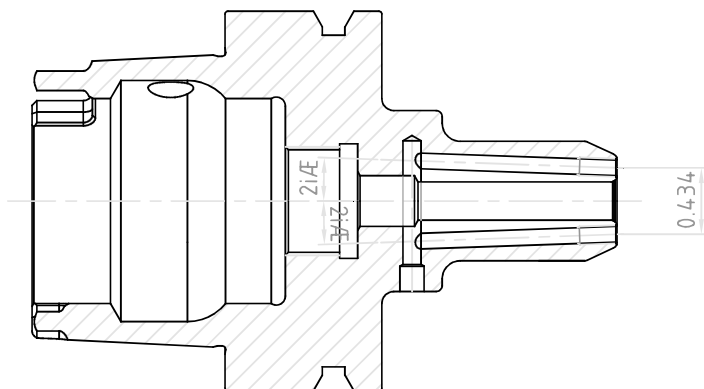

 YG-1 CO., LTD.	DESCRIPTION		
	HSK63A-EMH1/4(6.35)C-2.56(65)		
EDP No.	AQ020C	SCALE	1 : 1