

NO.	REVISIONS	DATE	DEVISER
1.			
2.			
3.			

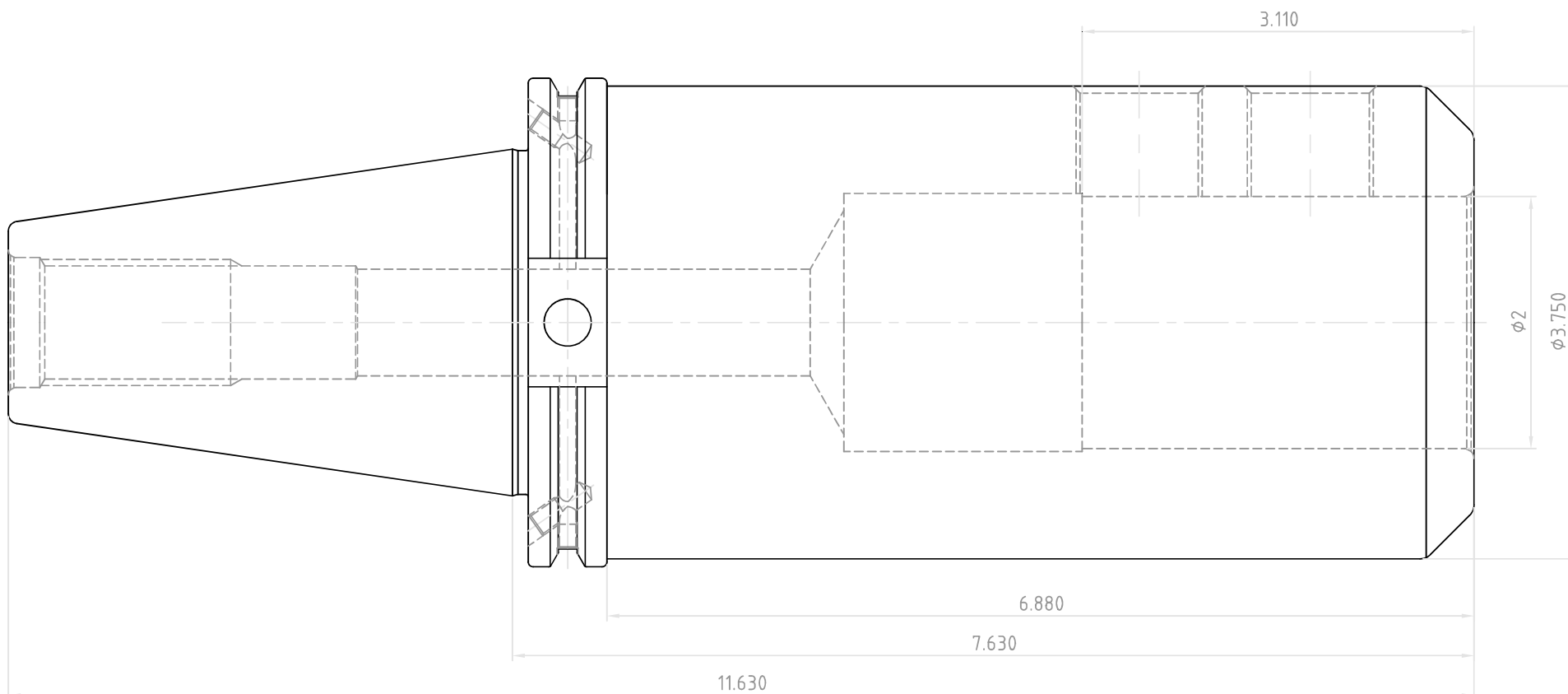

 YG-1 CO., LTD.	DESCRIPTION		
	CAT50AD/B-EMH2(50.8)-7.63(193.8)		
EDP No.	AL129B	SCALE	1 : 1