

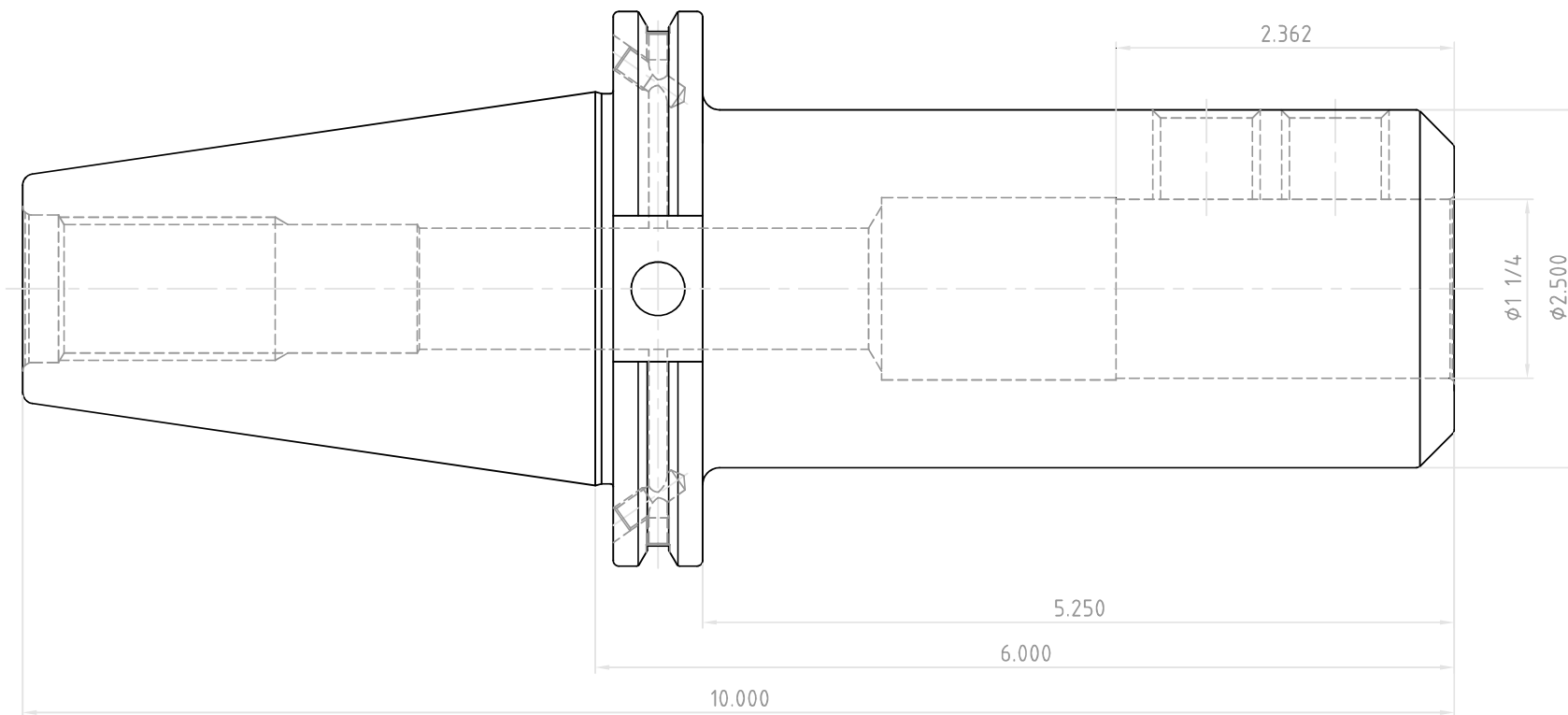

NO.	REVISIONS	DATE	DEVISER
1.			
2.			
3.			



 YG-1 CO., LTD.	DESCRIPTION	
	CAT50AD/B-EMH1 1/4(31.75)-6.00(152.4)	
EDP No.	AL117B	SCALE 1 : 1