

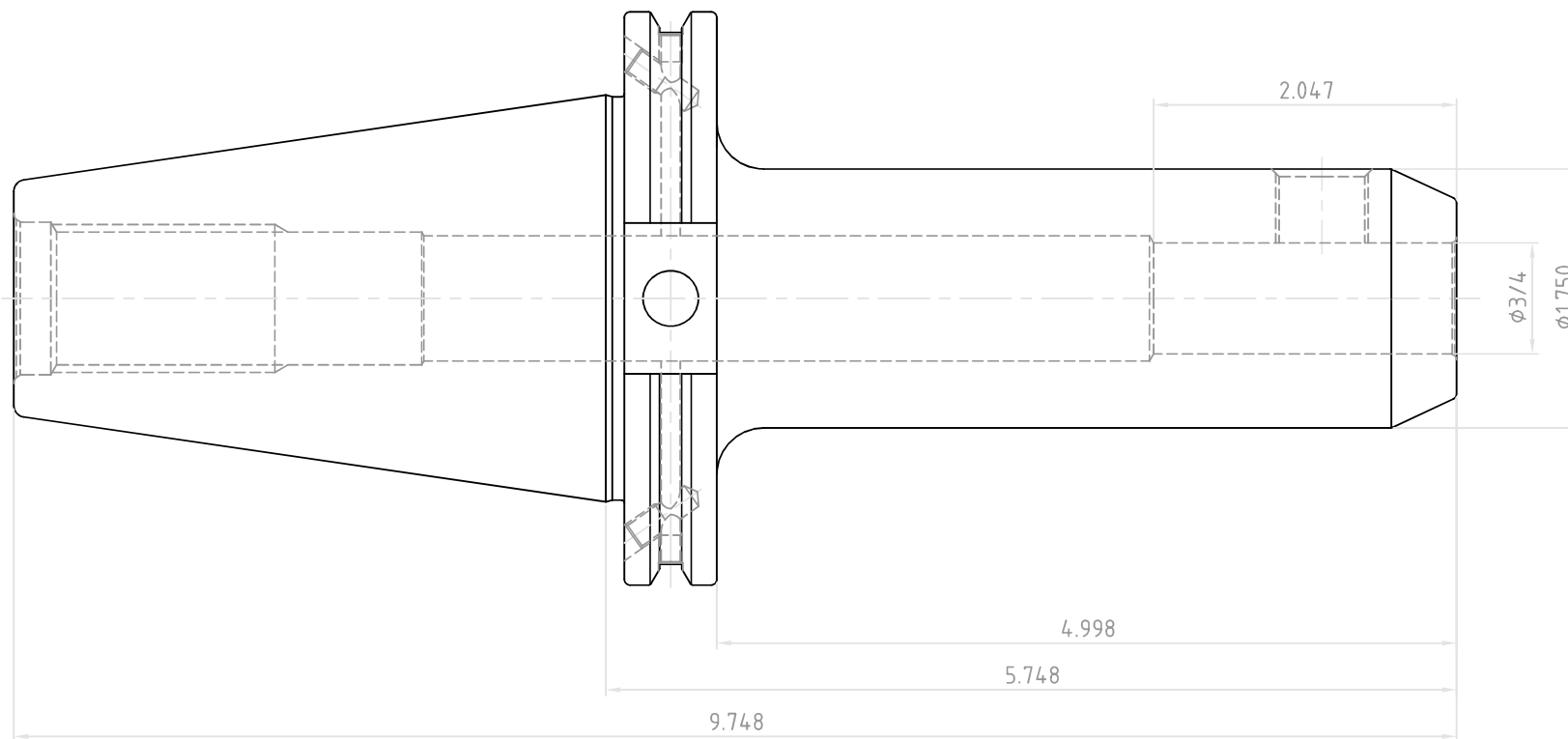

NO.	REVISIONS	DATE	DEVISER
1.			
2.			
3.			



 YG-1 CO., LTD.	DESCRIPTION	
	CAT50AD/B-EMH3/4(19.05)-5.75(14.6)	
EDP No.	AL110B	SCALE 1 : 1