

NO.	REVISIONS	DATE	DEVISER
1.			
2.			
3.			

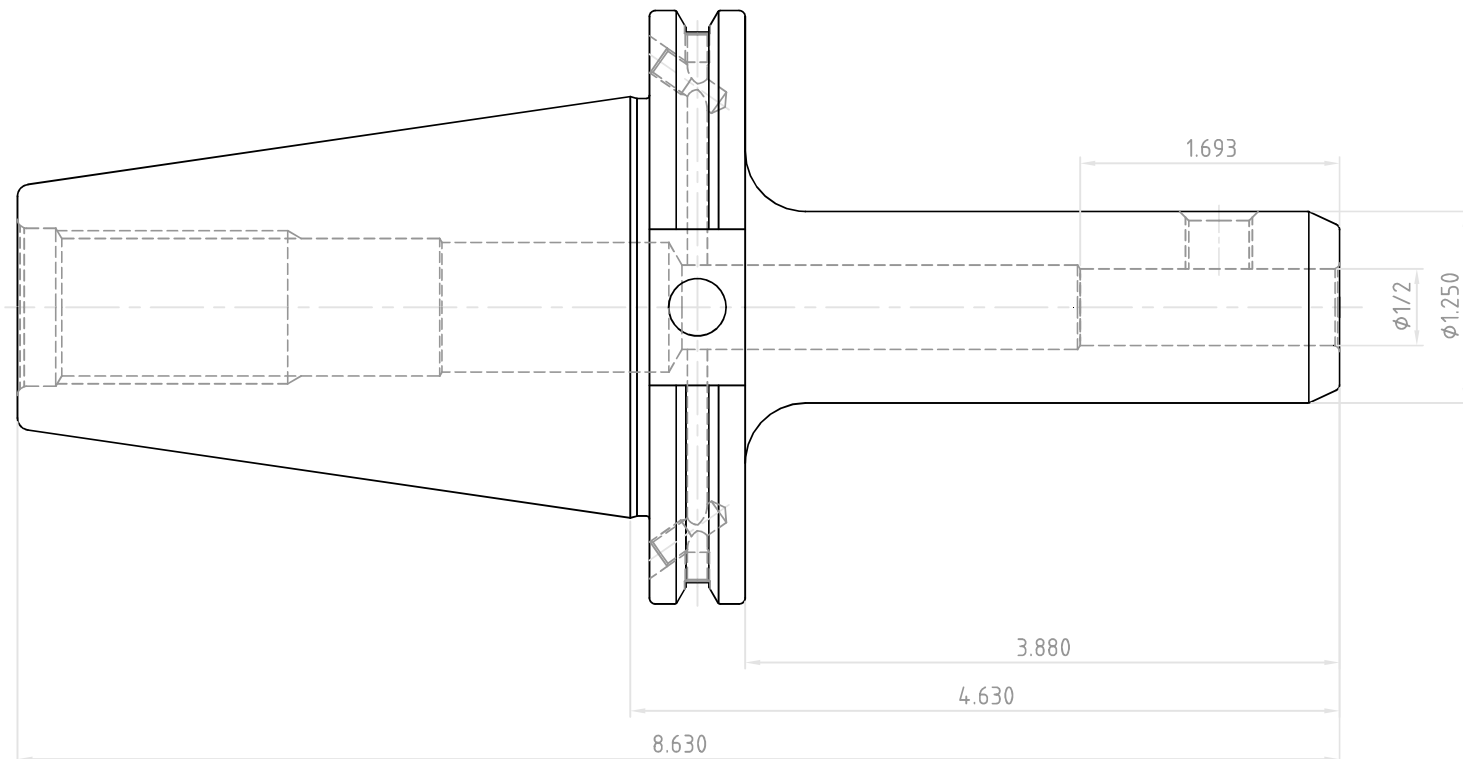

 YG-1 CO., LTD.	DESCRIPTION	
	CAT50AD/B-EMH1/2(12.7)-4.63(117.6)	
EDP No.	AL106B	SCALE 1 : 1