

NO.	REVISIONS	DATE	DEVISER
1.			
2.			
3.			

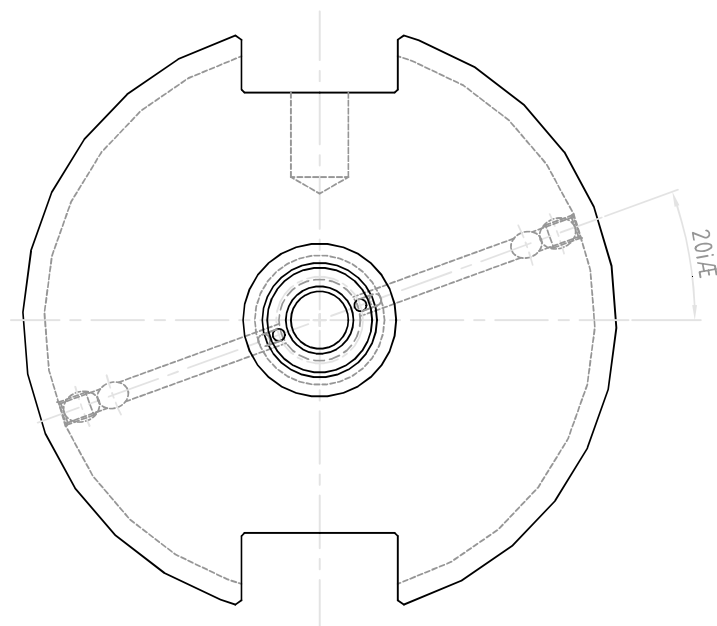
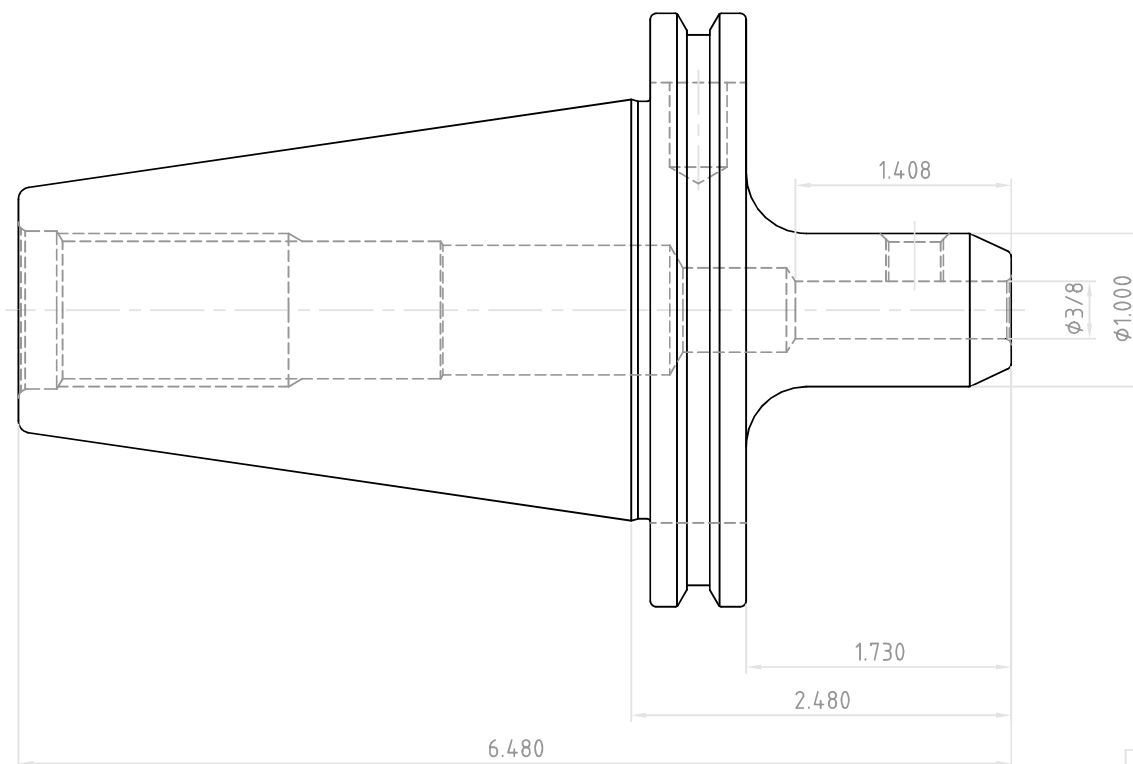
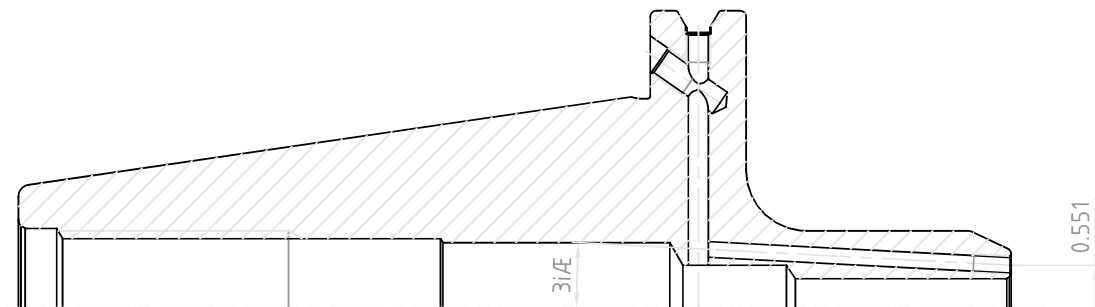

 YG-1 CO., LTD.	DESCRIPTION		
	CAT50AD/B-EMH3/8(9.52)C-2.48(63)		
	EDP No.	AL004C	SCALE 1 : 1