

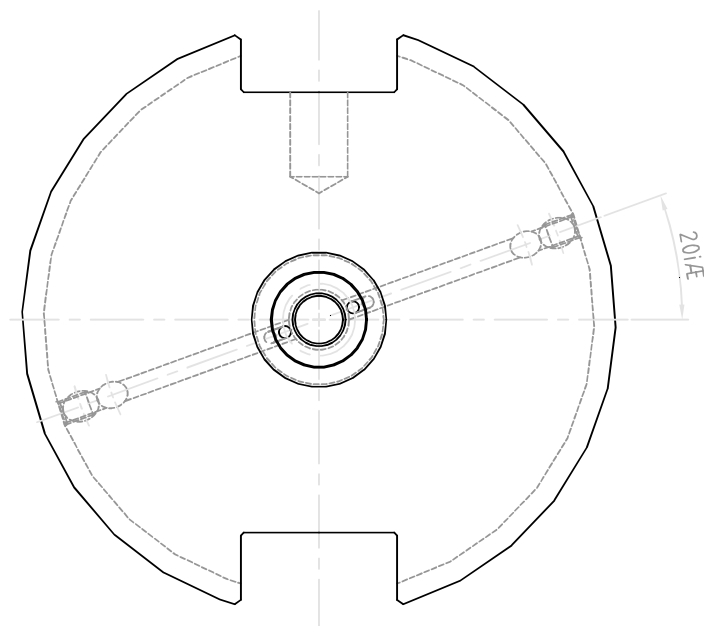

NO.	REVISIONS	DATE	DEVISER
1.			
2.			
3.			

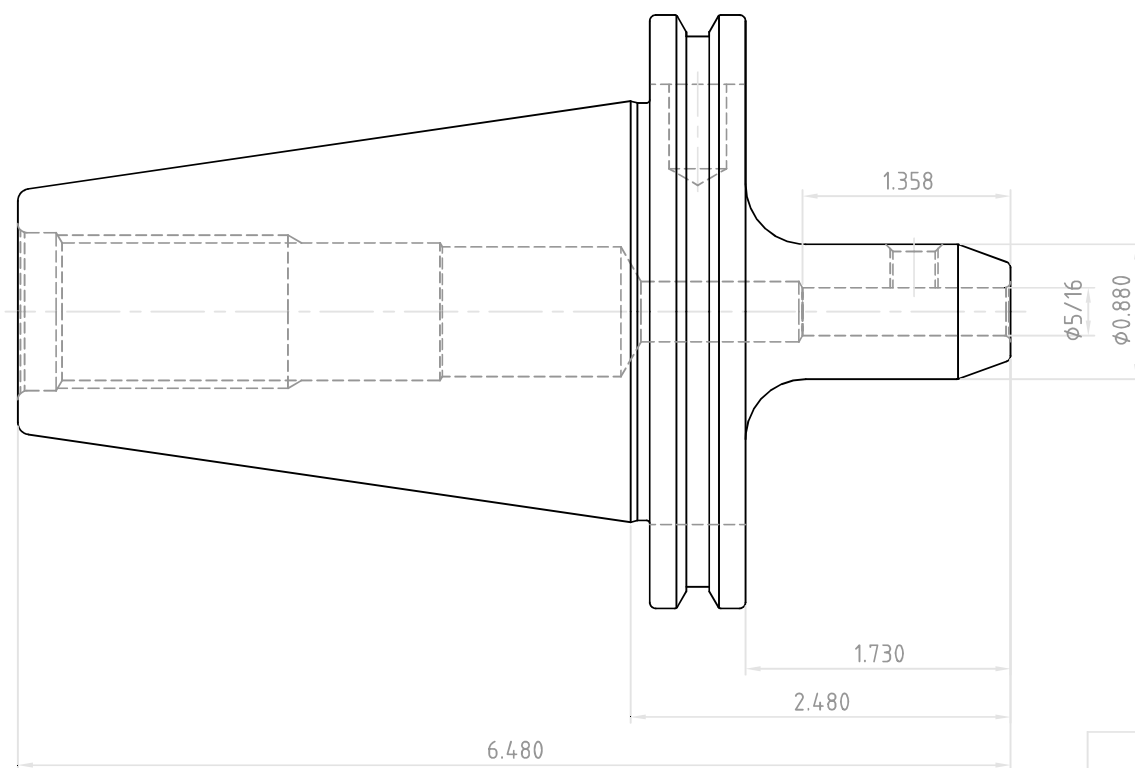
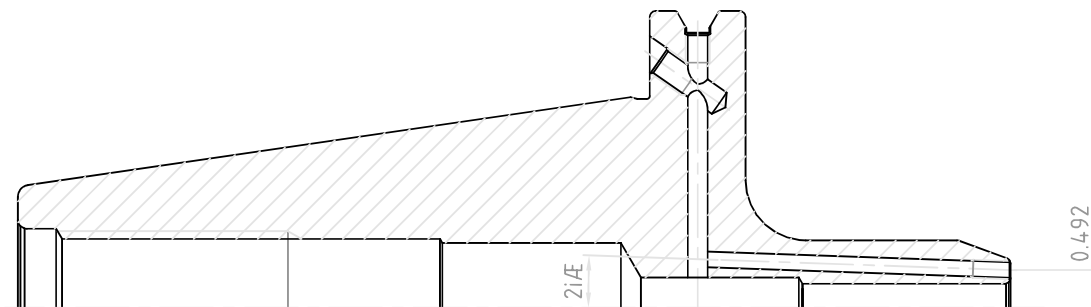

 YG-1 CO., LTD.	DESCRIPTION		
	CAT50AD/B-EMH5/16(7.93)C-2.48(63)		
EDP No.	AL003C	SCALE	1 : 1