

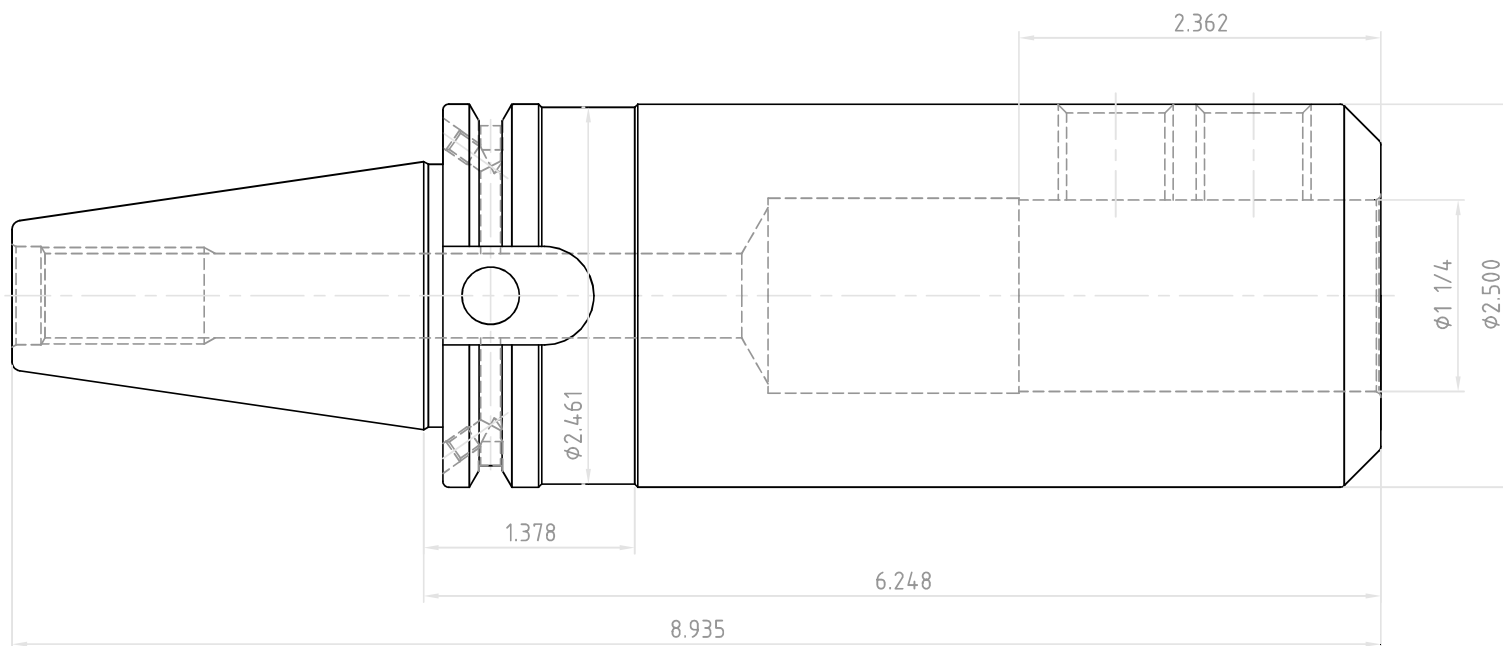

NO.	REVISIONS	DATE	DEVISER
1.			
2.			
3.			



 YG-1 CO., LTD.	DESCRIPTION	
	CAT40AD/B-EMH1 1/4(31.75)-6.25(158.7)	
EDP No.	AK117B	SCALE 1 : 1