

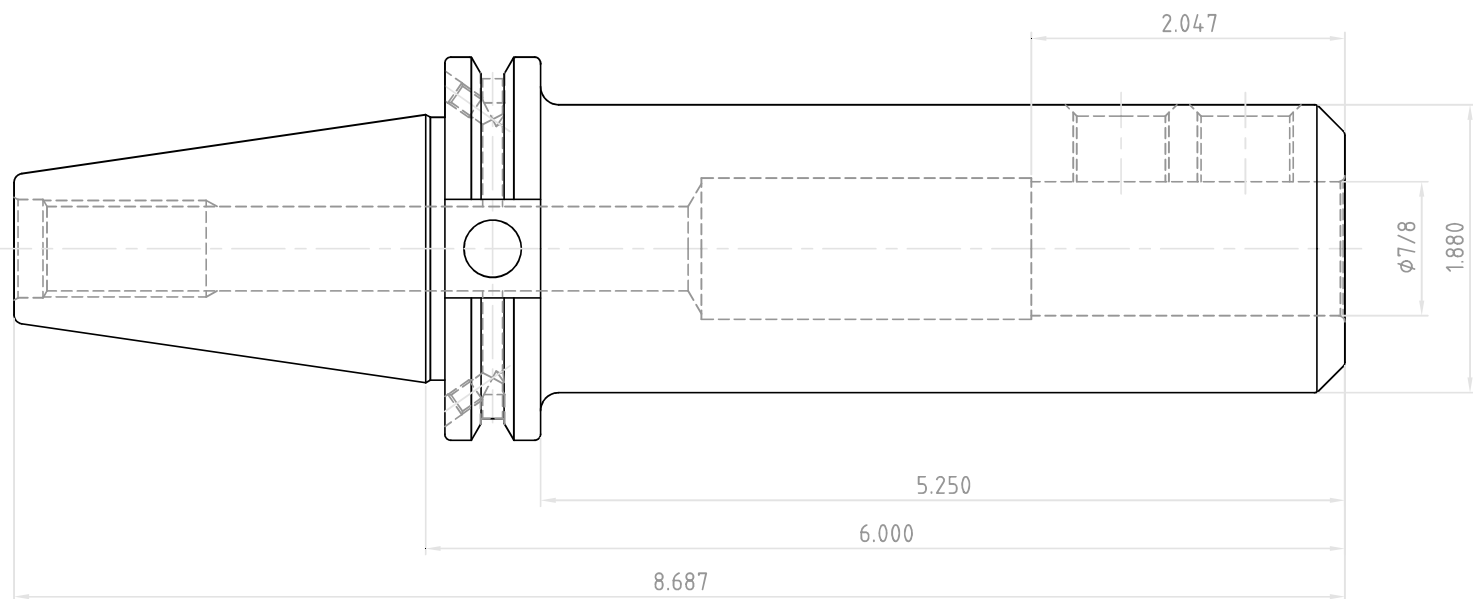

NO.	REVISIONS	DATE	DEVISER
1.			
2.			
3.			



 YG-1 CO., LTD.	DESCRIPTION	
	CAT40AD/B-EMH7/8(22.22)-6.00(152.4)	
	EDP No.	AK112B
	SCALE	1 : 1