

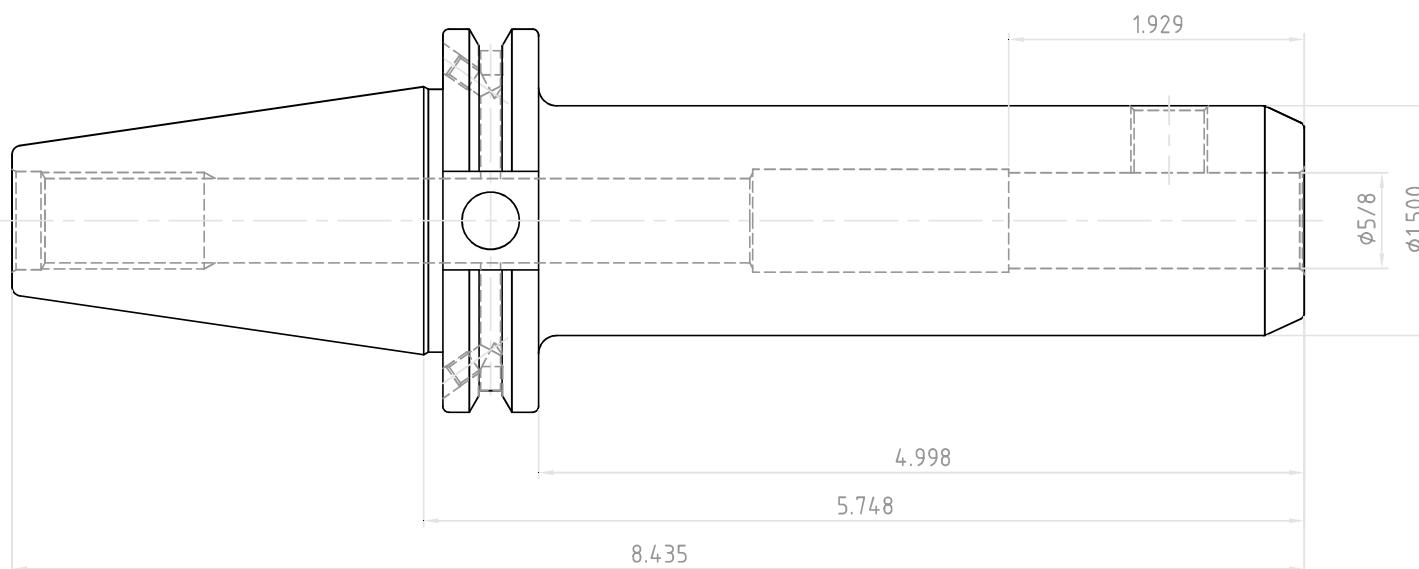

NO.	REVISIONS	DATE	DEVISER
1.			
2.			
3.			



 YG-1 CO., LTD.	DESCRIPTION	
	CAT40AD/B-EMH5/8(15.87)-5.75(14.6)	
EDP No.	AK108B	SCALE 1 : 1