

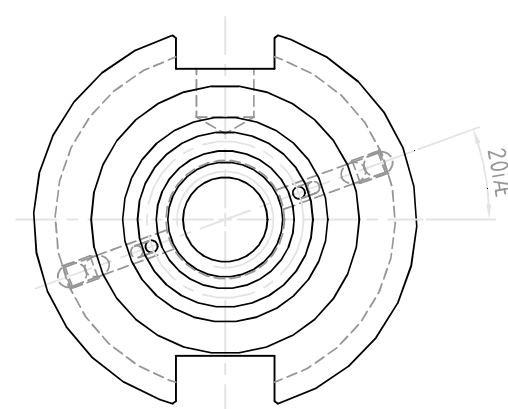

NO.	REVISIONS	DATE	DEVISER
1.			
2.			
3.			

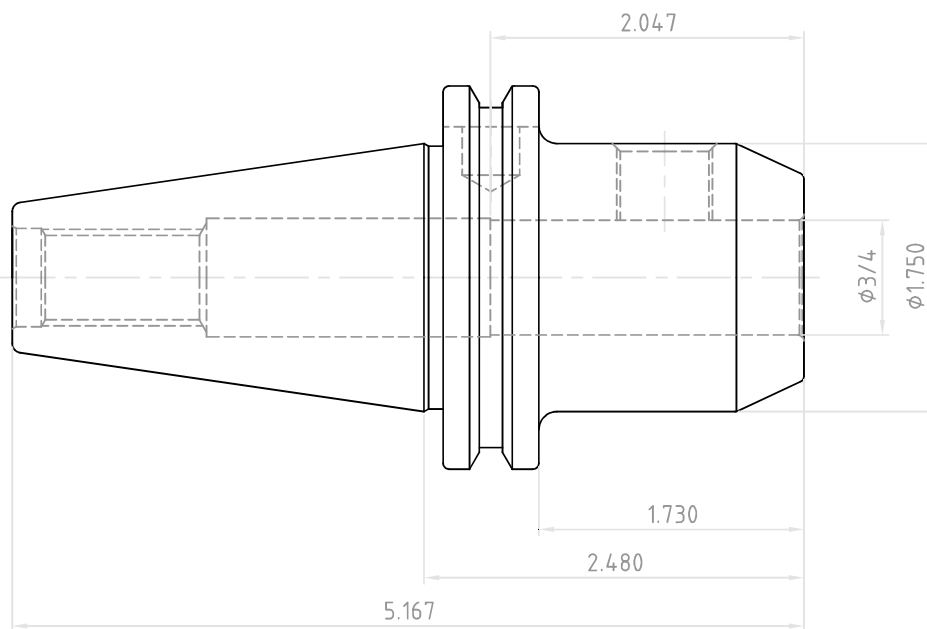
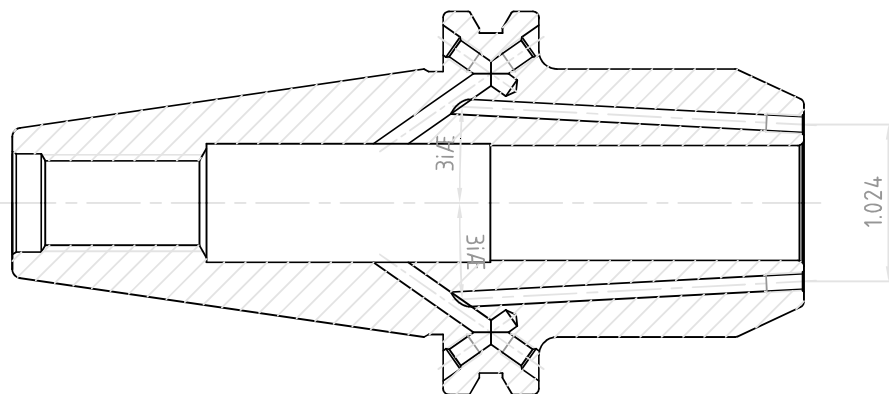

 YG-1 CO., LTD.	DESCRIPTION	
	CAT40AD/B-EMH3/4(19.05)C-2.48(63)	
EDP No.	AK010C	SCALE 1 : 1