

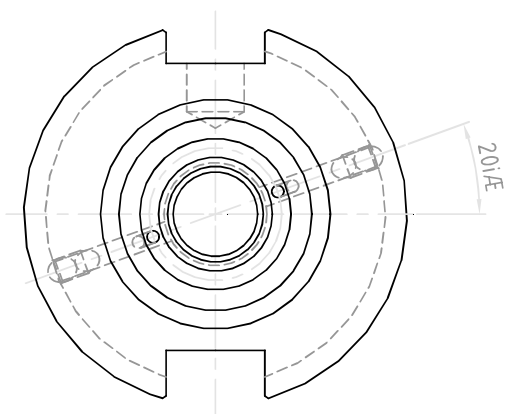

NO.	REVISIONS	DATE	DEVISER
1.			
2.			
3.			

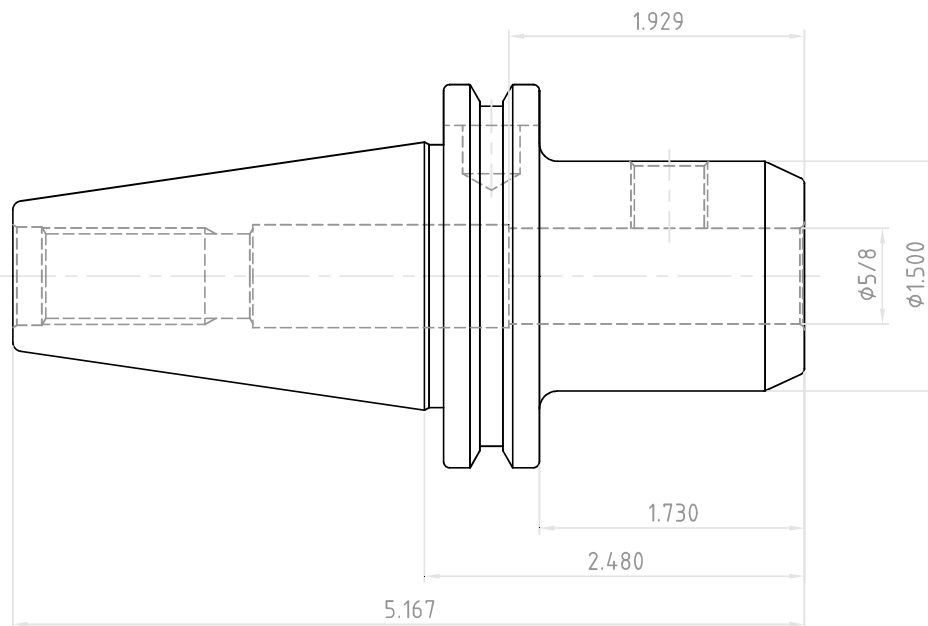
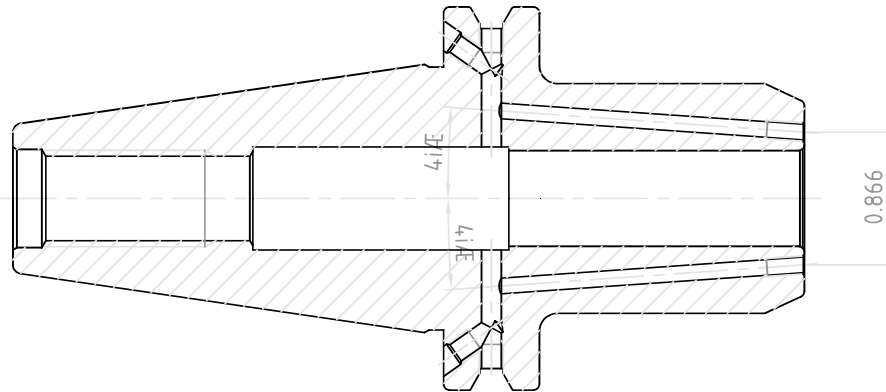

 YG-1 CO., LTD.	DESCRIPTION		
	CAT40AD/B-EMH5/8(15.87)C-2.48(63)		
	EDP No.	AK008C	SCALE 1 : 1