

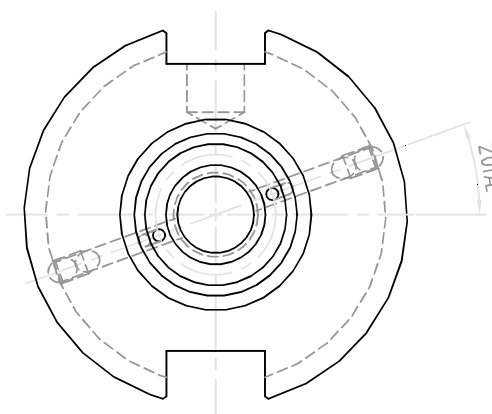

NO.	REVISIONS	DATE	DEVISER
1.			
2.			
3.			

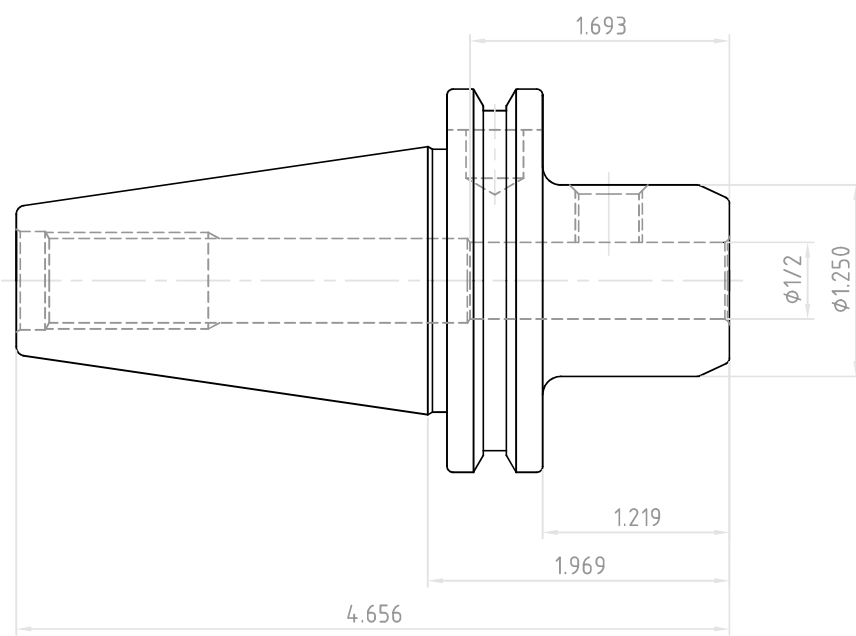
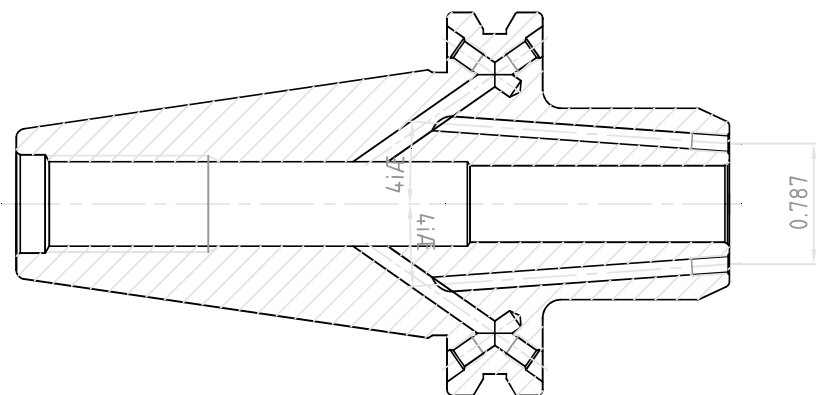

 YG-1 CO., LTD.	DESCRIPTION	
	CAT40AD/B-EMH1/2(12.7)C-1.97(50)	
EDP No.	AK005C	SCALE 1 : 1