

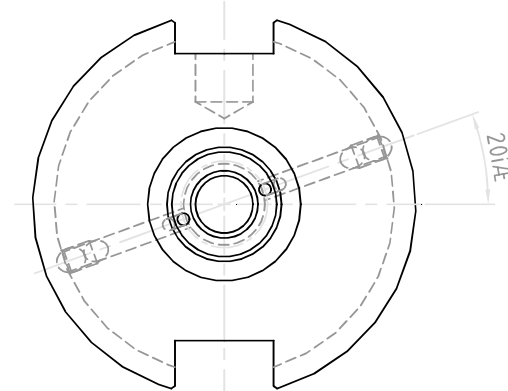

NO.	REVISIONS	DATE	DEVISER
1.			
2.			
3.			

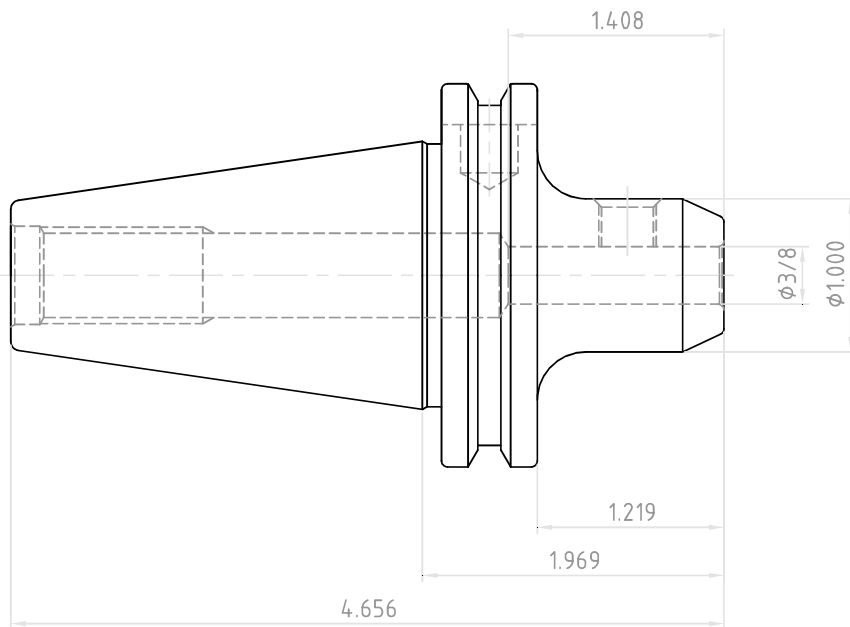
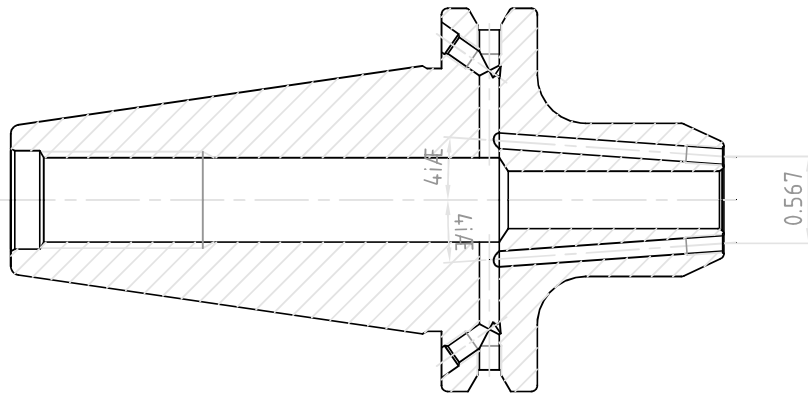

 YG-1 CO., LTD.	DESCRIPTION		
	CAT40AD/B-EMH3/8(9.52)C-1.97(50)		
EDP No.	AK004C	SCALE	1 : 1