

NO.	REVISIONS	DATE	DEVISER
1.			
2.			
3.			

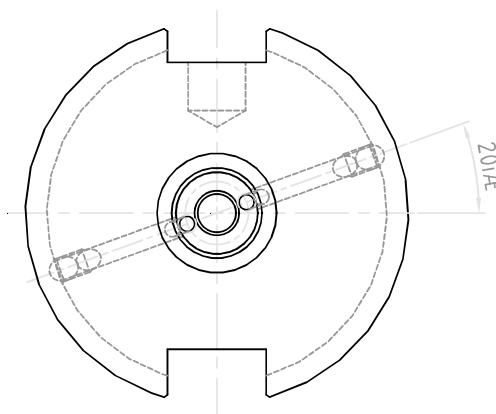
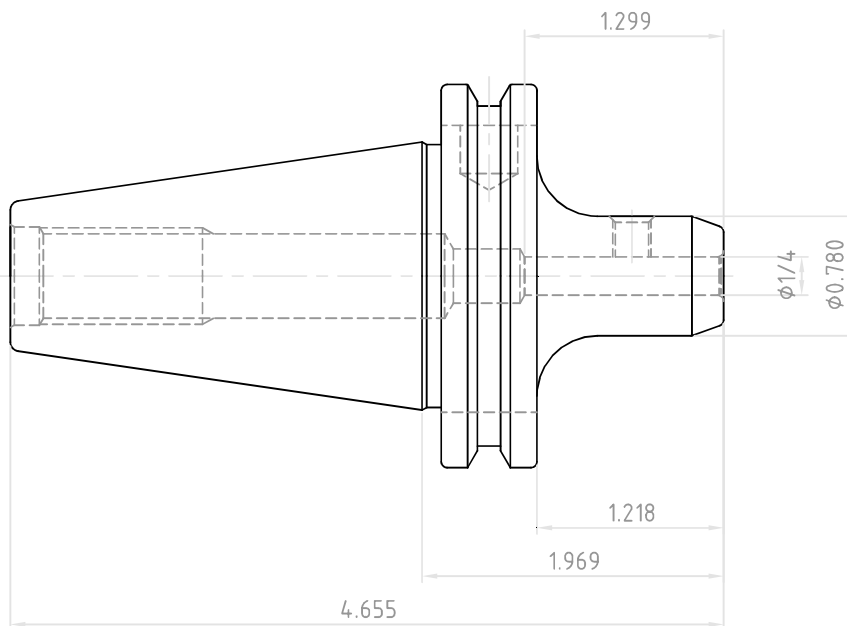
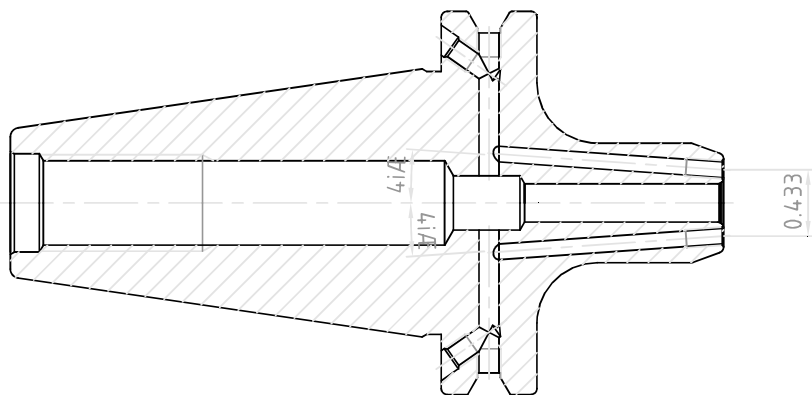

 YG-1 CO., LTD.	DESCRIPTION		
	CAT40AD/B-EMH1/4(6.35)C-1.97(50)		
	EDP No.	AK002C	SCALE 1 : 1