

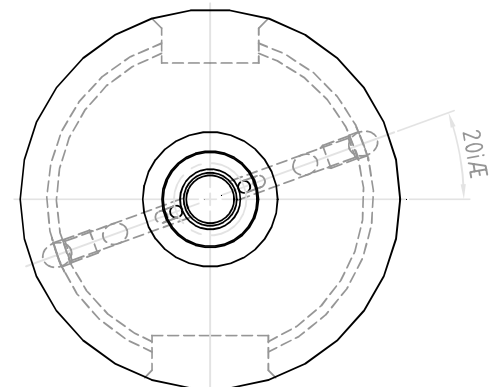

NO.	REVISIONS	DATE	DEVISER
1.			
2.			
3.			

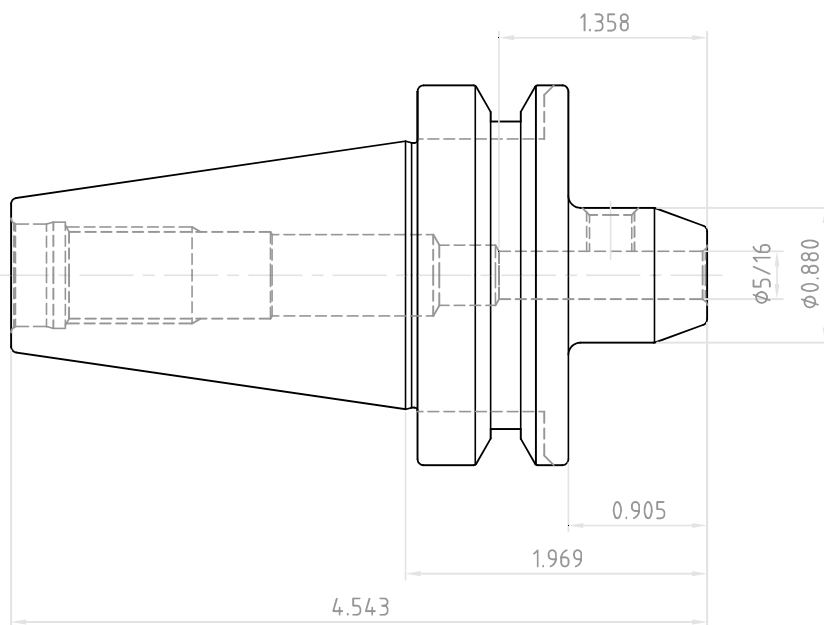
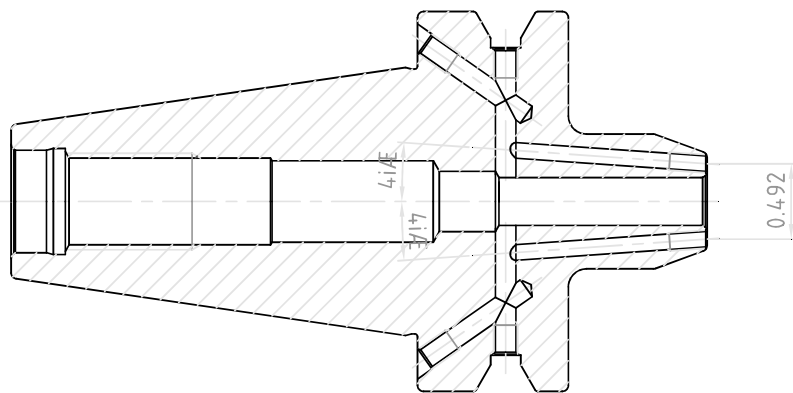

 YG-1 CO., LTD.	DESCRIPTION		
	BT40AD/B-EMH5/16(7.93)C-1.97(50)		
	EDP No.	AH003C	SCALE 1 : 1