

NO.	REVISIONS	DATE	DEVISER
1.			
2.			
3.			

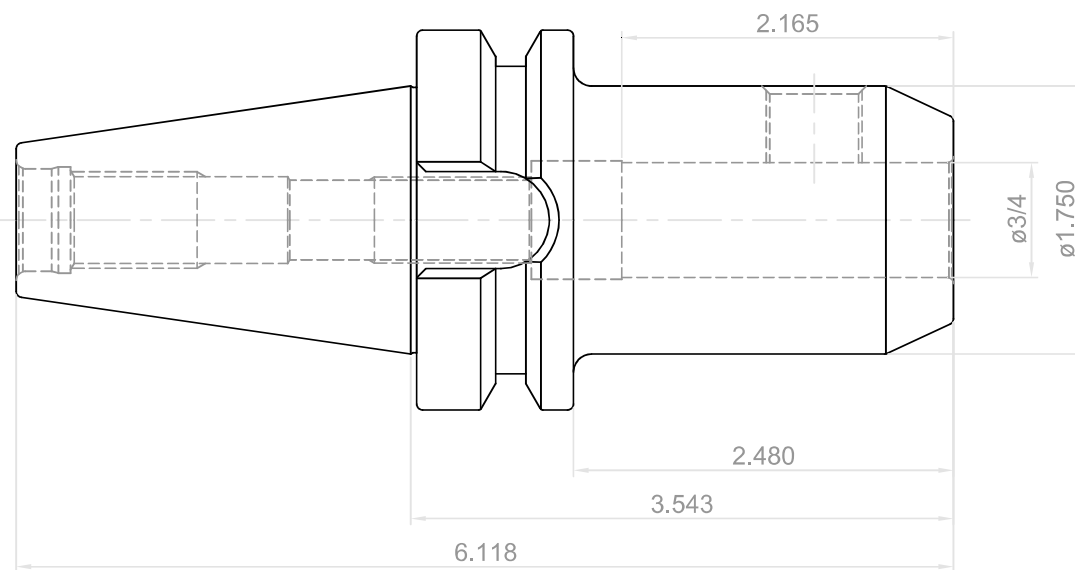

 YG-1 CO., LTD.	DESCRIPTION	
	CBT40-SLA3/4(19.05)-3.54(90)	
EDP No.	AE030	SCALE 1 : 1