

NO.	REVISIONS	DATE	DEVISER
1.			
2.			
3.			

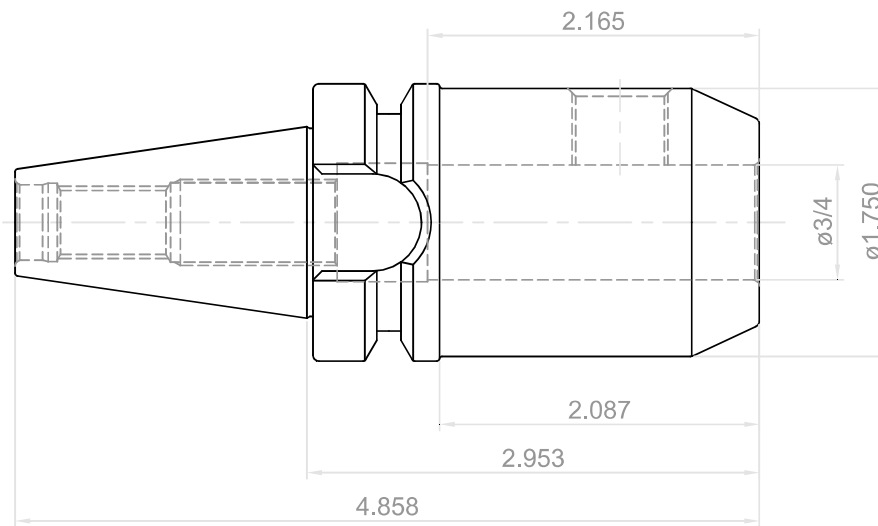

 YG-1 CO., LTD.	DESCRIPTION	
	CBT30-SLA3/4(19.05)-2.95(75)	
EDP No.	AD030	SCALE 1 : 1