

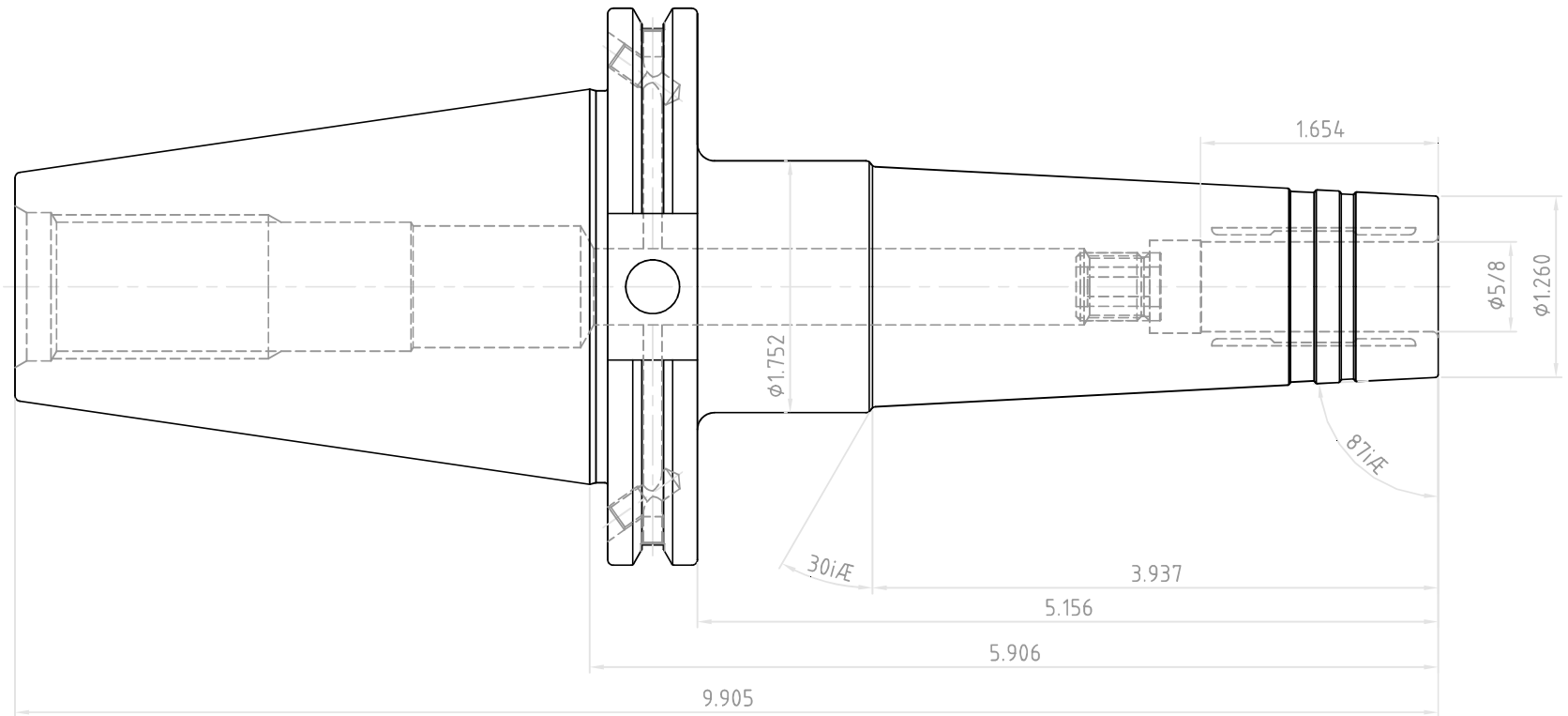

| NO. | REVISIONS | DATE | DEVISER |
|-----|-----------|------|---------|
| 1. | | | |
| 2. | | | |
| 3. | | | |



| | | | |
|--|-----------------------------------|----------|-------------|
|  YG-1 CO., LTD. | DESCRIPTION | | |
| | CAT50AD/B-HMC5/8(15.87)-5.91(150) | | |
| | EDP No. | WL028HMC | SCALE 1 : 1 |