

| NO. | REVISIONS | DATE | DEVISER |
|-----|-----------|------|---------|
| 1. | | | |
| 2. | | | |
| 3. | | | |

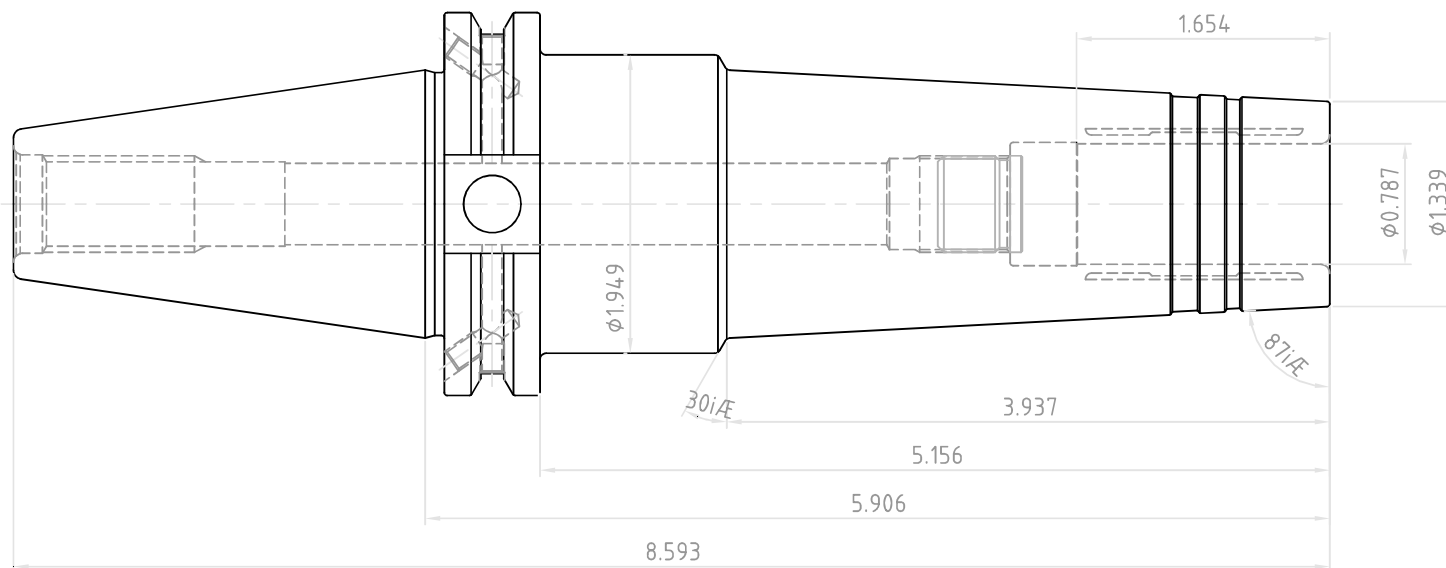

| | | | |
|--|---------------------------------|----------|-------------|
|  YG-1 CO., LTD. | DESCRIPTION | | |
| | CAT40AD/B-HMC0.79(20)-5.91(150) | | |
| | EDP No. | WK122HMC | SCALE 1 : 1 |